

HEATER
CONTROLLER
-
HORIZONTAL

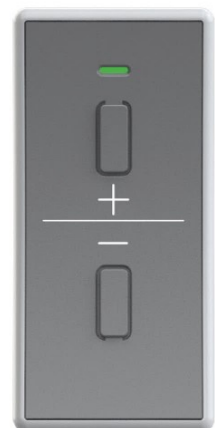

+
REMOTE
CONTROLLER



GUIDE & USER MANUAL





SAFETY:

1. **The heater should be installed by a qualified person.**
2. Bathroom radiators fitted with electric heaters should be fixed not less than 60 cm from a bath, shower or wash basin, and never above a bath.
3. For the heater permanently connected (hard wire) there must be applied a cut-off device from the mains. Such a device must disconnect the heater from the supply mains in 2 poles, with contact separation of at least 3 mm.
4. This appliance can be used by children aged from 8 years and above and persons with reduced physical, sensory or mental capabilities or lack of experience and knowledge if they have been given supervision or instruction concerning use of the appliance in a safe way and understand the hazards involved
5. Children shall not play with the appliance. Cleaning and user maintenance shall not be made by children without supervision.
6. **The heater MUST BE DISCONNECTED before cleaning the casing. AVOID SOAKING THE CASING.**
7. One radiator valve must always be open when a heater is in use (liquid thermal expansion).

CAUTION: To avoid the risk of fire or electric shock the heater should be protected from water spray or flooding. This appliance is not intended for use by persons (including children) of limited physical, sensory or mental abilities, or persons inexperienced or not familiar with the appliance, unless supervised or instructed on the appliance use by persons responsible for their safety. Particular attention should be paid to children, to preclude playing with the appliance by them. Exclamation mark on triangular field signals:  **information important for the user.**

CAUTION: electric shock hazard!, lightning mark ended with arrow on triangular field 

CAUTION: in order to reduce electric shock hazard, do not remove the casing (nor its rear cover). There are no user-serviceable parts inside the appliance; the product must be returned to the manufacturer for repair via the distributor who sold the product.

GUARANTEE TERMS:

Guarantee is granted by manufacturer for 24 months period starting from date of sale, but no longer than 36 months from date of the heater manufacture. Defects revealed within this period, resulting from a fault of manufacturer will be repaired free of charge or the item replaced with new, equivalent one. Term of complaints' investigation up to 14 (fourteen) days from date of submission to the manufacturer.

Guarantee does not cover:

1. Using of product in a manner noncompliant with attached instructions.
2. Any visible damage to the heating element or controller due to improper use. Damaging of manufacturer's seals makes the guarantee null and void.

In the event that Heatpol are unable to repair or replace this product we reserve the right to refund the purchase price as an alternative.

GUARANTEE CARD

Serial No.:

Date of sale:

Stamp of retail outlet, signature of seller

Eastbrook 
Eastbrook Road, Gloucester GL4 3DB
Technical Helpline : 01452 317890
Mon - Fri / 8am - 5pm
Email : technical@eastbrookco.com

MADE IN EU

Caution: The guarantee card should be legibly filled in retail outlet. Any corrections on the guarantee card will invalidate the guarantee. Guarantee card valid only with proof of purchase.

USER MANUAL: Heating element + Heater controller (horizontal) H+h

Kit content

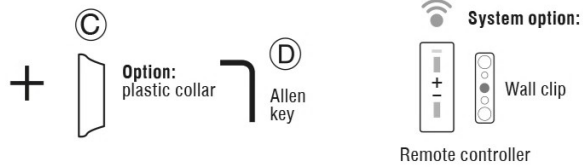
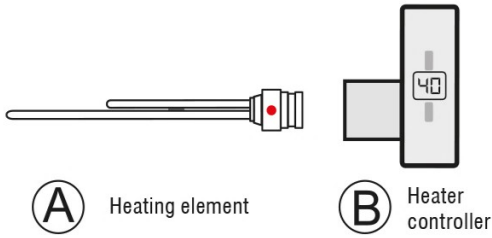

Side connection

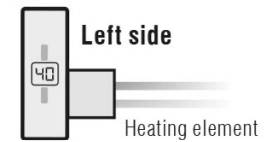
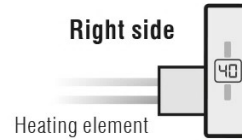
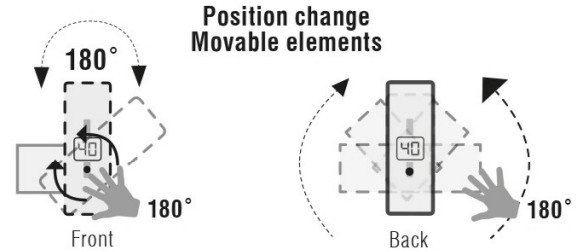

Mounting in radiators

CH system



Electric radiators

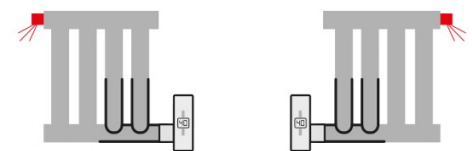

The electric heater must have a safety valve

Installation details

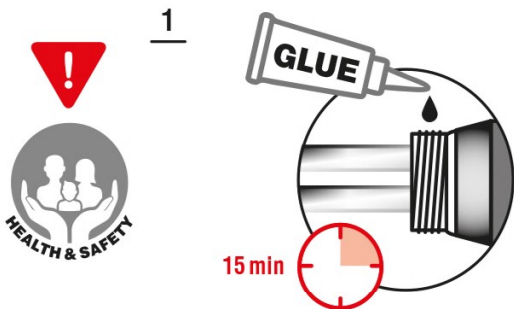

Before you apply the heating element, spread the Loctite glue (included in the set) on the middle of the thread circumference.

GLUE

2 The order of assembly of elements

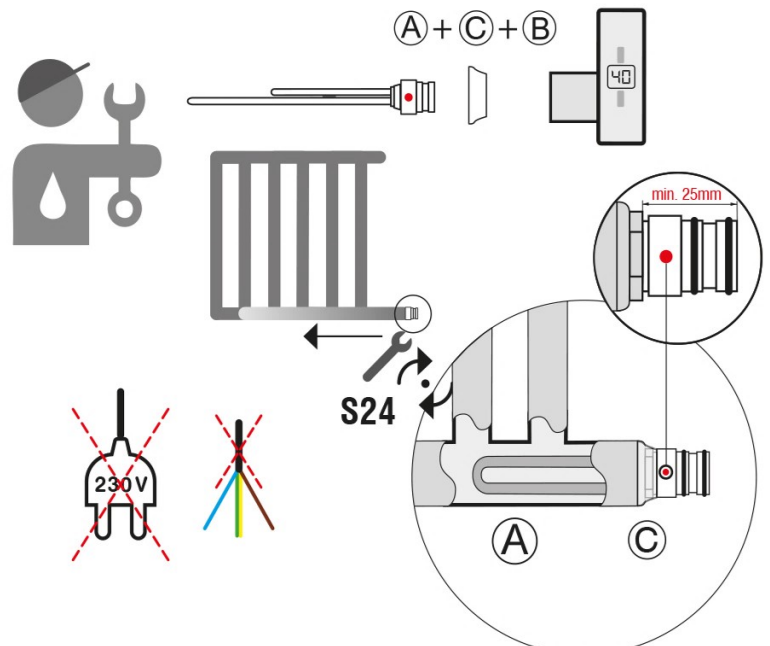

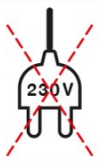

CAUTION! Do not disconnect heater controller when the system is powered.

The locking screw must be protected against accidental unscrewing eg. by applying a drop of lacquer or acrylic adhesive.

3

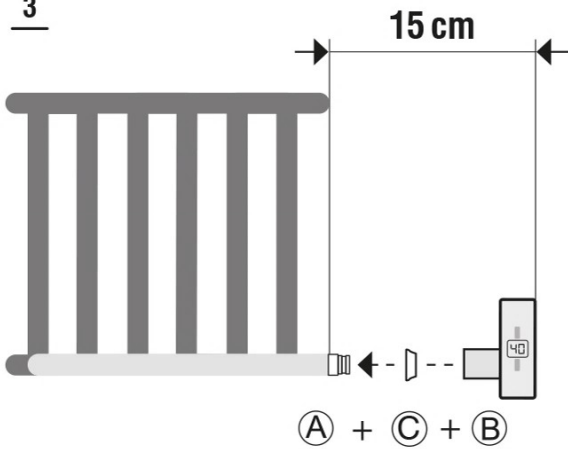

4

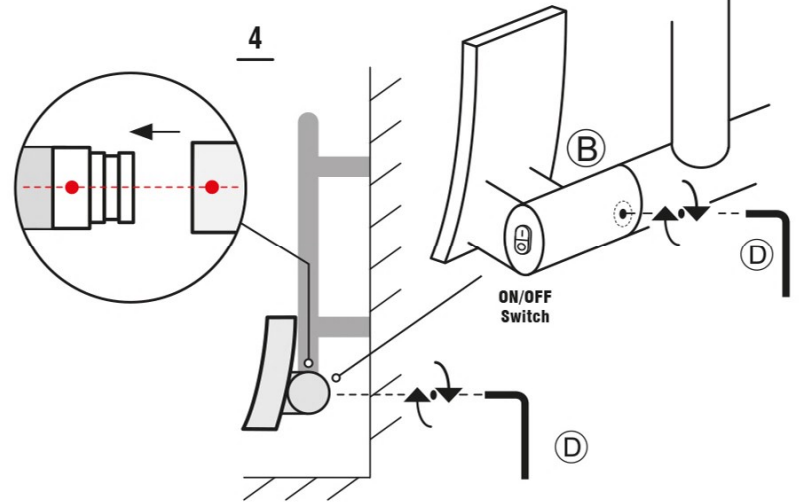

Electric radiators

CH system

5A

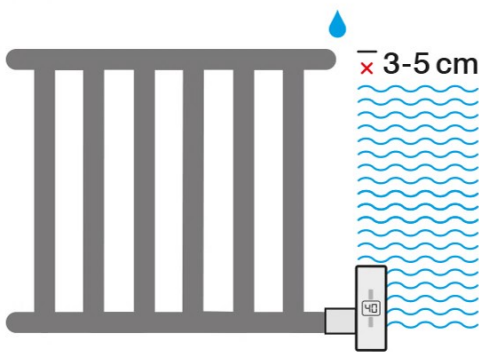

5B

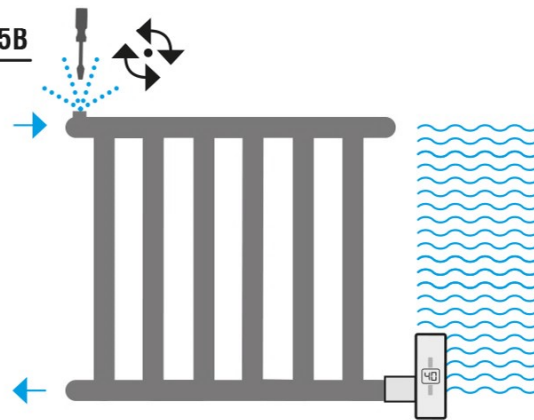

Before you apply the heating element, spread the Loctite glue (included in the set) on the middle of the thread circumference.



6A

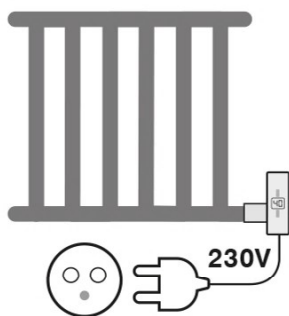

6B

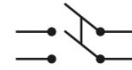
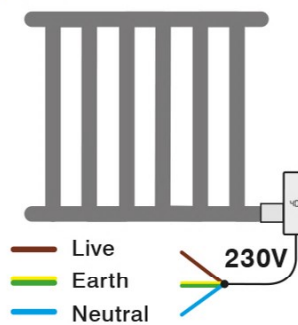

For the heater permanently connected (hard wire) there must be applied a cut-off device from the mains. Such a device must disconnect the heater from the supply mains in 2 poles, with contact separation of at least 3 mm

7

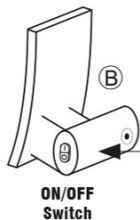

After electric connection, turn on the switch

When connected, the heater broadcasts its Wi-Fi network and is ready for configuration.

USER MANUAL: How to use heater controller (optional remote controller)

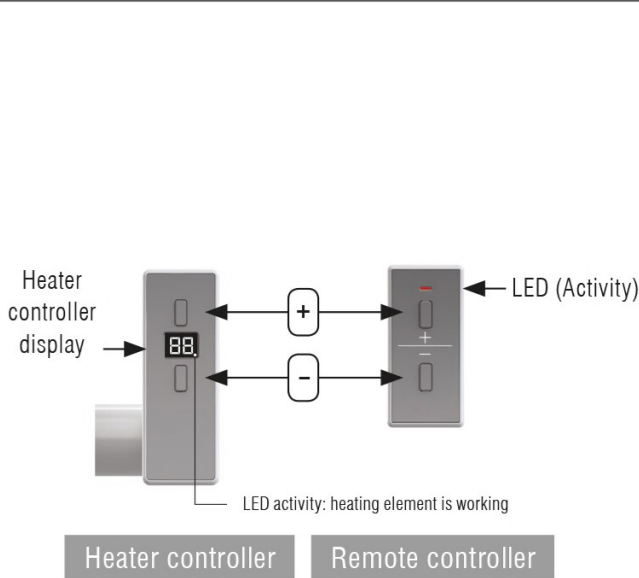

Heater controller



Connect heater controller to the heater
Use manufacturer recommendation
Turn ON the controller



Remote controller

Locate suitable place to mount the remote

Due to proper temperature reading do not place a remote controller (temperature sensor) over radiators, next to doors or in sunny places.

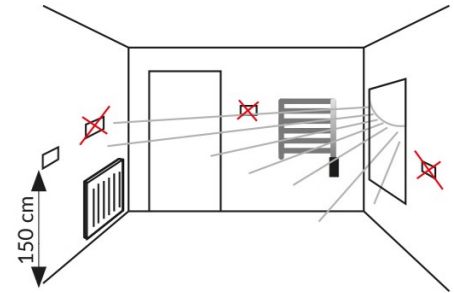

Push for pairing button using allen key to activate the controller

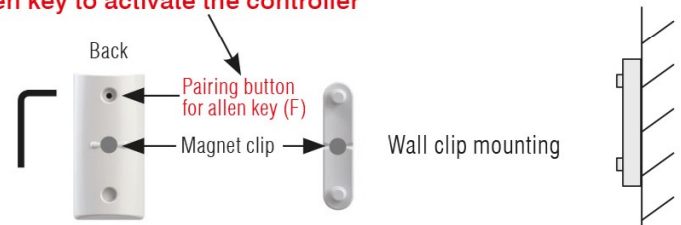

1

START: Heater controller and remote controller pairing

If you bought a remote controller together with H+heater you do not need to pair it!

Prepare remote controller + allen key for use (D)

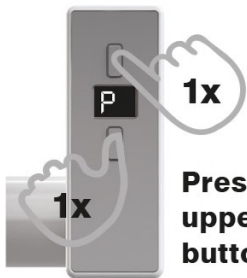

Press once upper and lower button together



Hold 3 sec.
Start countdown



During countdown within 30 seconds

Reverse remote controller.
Push pairing button!



Pairing finished!

Remote controller is already working

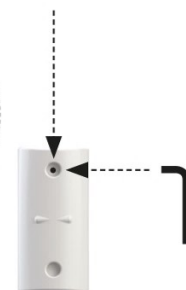

Allen key included

For H+h WiFi controller please download smartphone application from www.supla.org and follow the instruction.

2

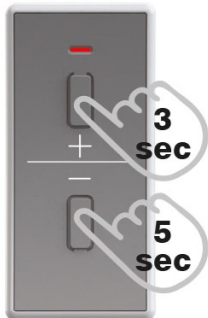

Run the heater controller via remote controller

Hold upper button for 3 seconds

Switch off the controller via remote controller

Hold lower button for 5 seconds

40°C

Standard heating temperature

3

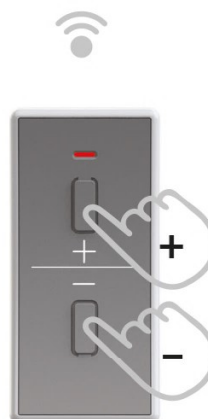

10°C - 65°C*

Select temperature

4

TURBO mode activation

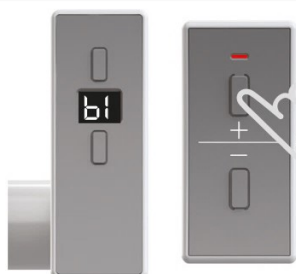

TURBO mode activation - max heating temperature

Hold button for 3 seconds

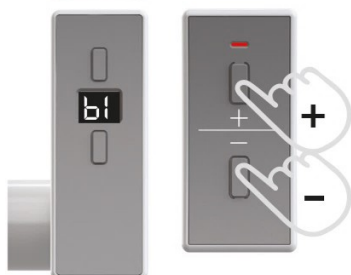

b1-b2-b3

Max heating temperature, **selection for 1/2/3 hours**

b0

Off selection

Settings water or ambient temperature

Errors

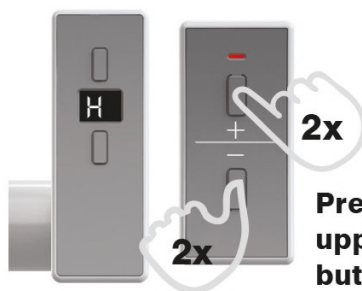

Press twice upper and lower button together

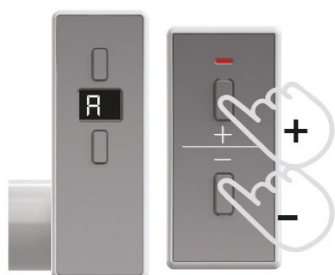

Temperature selection.

H Water temperature 10-65°C*

R Ambient temperature 10-30°C

The remote is a temperature sensor



* maximum temperature can be different according to the producer settings

E1 Lack of water (or wrong choice of heating element to the heater)

E2 Damaged heating element (or no power circuit)

E3 No communication to the remote controller if paired

DO NOT DISCONNECT!

controller from heating element, when connected to the power supply





DOWNLOAD APPLICATION SUPLA.ORG



System requirements: ANDROID 3.1/IOS 8,2 or the latest version.

Please check whether the WiFi network frequency is 2,4 GHz.WiFi module works only with this frequency.

**Install the application on your devices.
The app will easily guide you through
individual installation steps.**





Eastbrook 

Eastbrook Road, Gloucester GL4 3DB

Technical Helpline : 01452 317890

Mon - Fri / 8am - 5pm

Email : technical@eastbrookco.com

MADE IN EU