

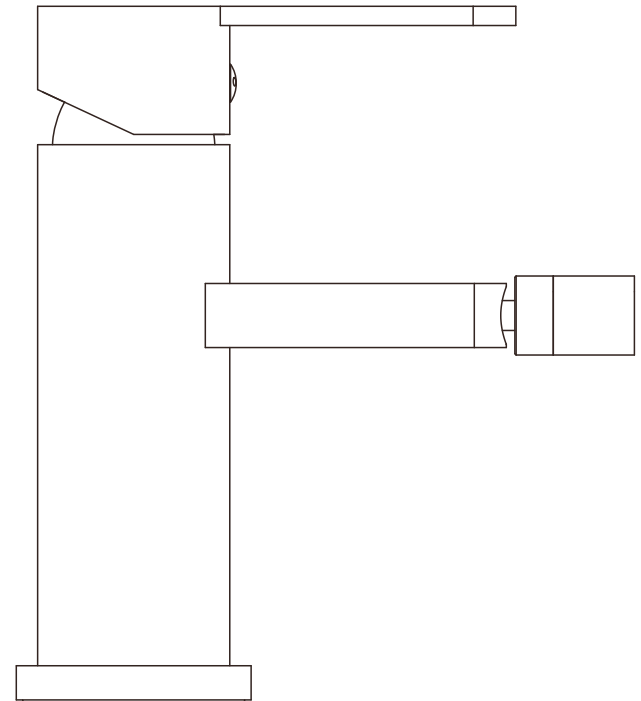

Eastbrook Road, Gloucester GL4 3DB  
Technical Helpline: 01452 317890  
email: [technical@eastbrookco.com](mailto:technical@eastbrookco.com)

# SINGLE LEVER BIDET MIXER



## Installation/Instruction

56.2016

Prado 800 mono bidet c/w click waste  
Manufacturers Code: 70414

## COMPONENTS

The monobasin contents the following :

- 1 Single lever bidet mixer
- 2 Connection sleeve with male screw
- 3 Rubber sleeve gasket
- 4 Steel sleeve gasket
- 5 Oval fixing nut
- 6 Flexible hose
- 7 Pop-up waste
- 8 Upper washer
- 9 Under washer
- 10 Fixing gasket
- 11 Fixing nut

check that all parts are correct

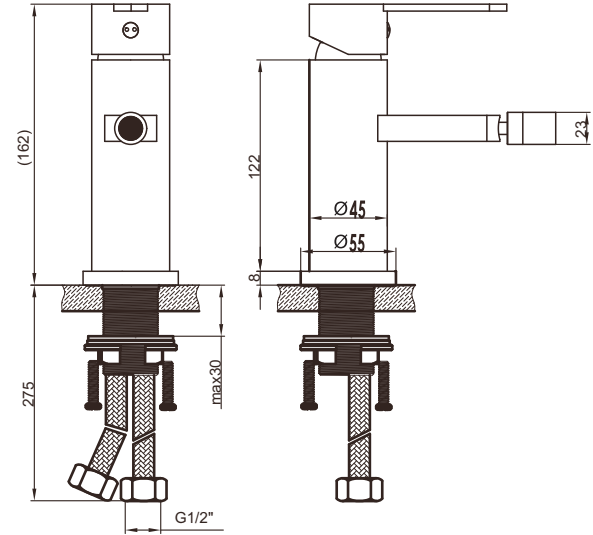
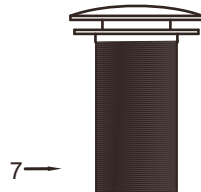
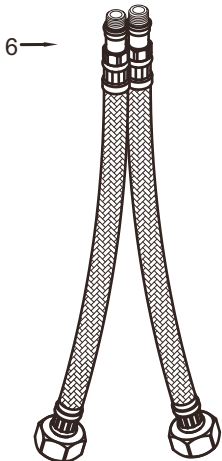
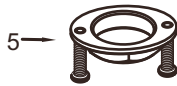
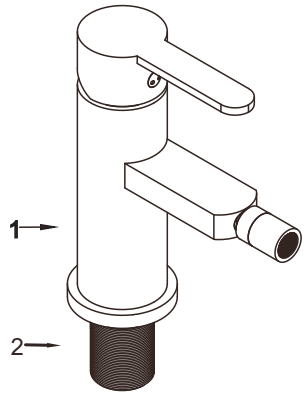

## INSTALLATION

- 1 Screw the stud into the hole in the base of the mixer unit and secure.
- 2 Slide the rubber seal and horseshoe plate over the stud and secure the mixer assembly in place using the nut provided.
- 3 Slide the silicon seal onto the upper waste outlet and fit the lower silicon seal onto the lip on the lower waste outlet place the upper waste fitting into the drainage hole in the monobasin. Screw the lower waste outlet into the upper waste outlet.

## Fitting the waste nut

Slide the silicon seal onto the upper waste outlet and fit the lower silicon seal onto the lip on the lower waste outlet.

Place the upper waste fitting into the drainage hole in the monobasin. Screw the lower waste outlet into the upper waste outlet.