

DATASHEET

Image



General Information

Product:	81.0146
Description:	Tunstall Double 800 x 600 Towel Rail
Website Link:	(Click Here)
Product Type:	Towel Rail
Brand:	Eastbrook Company
Colour:	Matt White
Material:	Mild Steel
Height (mm):	800mm
Width (mm):	600mm
Net Weight (kg):	17.5kg
Product Range:	Tunstall Double

Product Specifications

Warranty:	5 Year(s)
Supplied with fixings:	Yes
BTU $\Delta T50^{\circ}\text{C}$:	2166
BTU $\Delta T60^{\circ}\text{C}$:	2725
Watts $\Delta T50^{\circ}\text{C}$:	635
Watts $\Delta T60^{\circ}\text{C}$:	799

Drawing

Tunstall Double Towel Rail 800 x 600mm. Technical Drawing

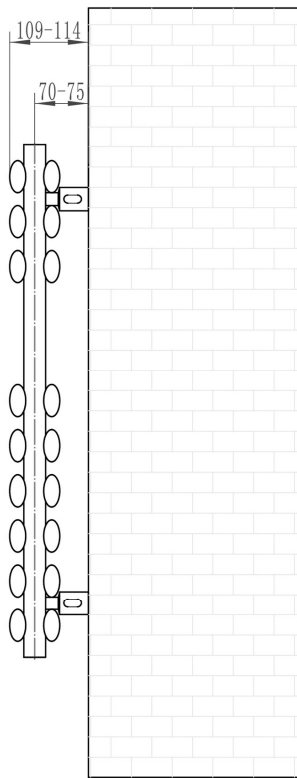

Tappings off wall : 70-75mm.

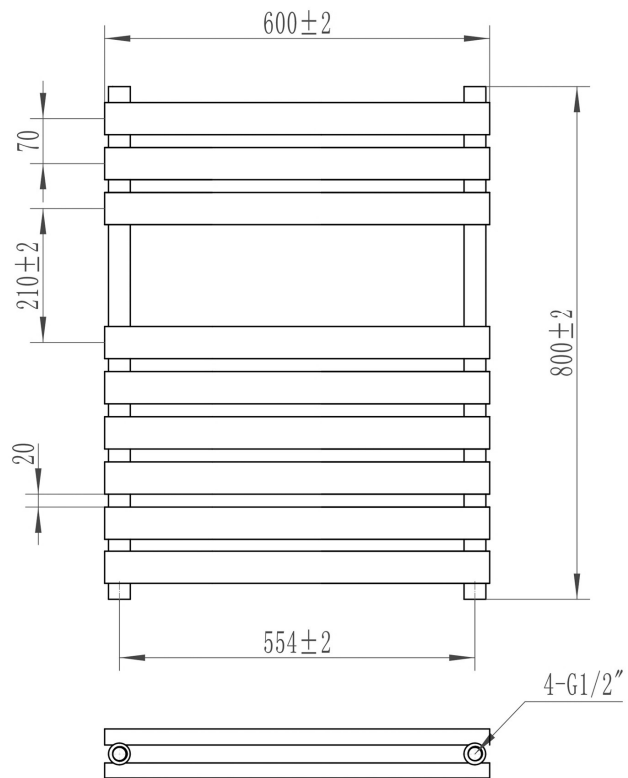

Eastbrook 
Eastbrook Road, Gloucester GL4 3DB
Technical Helpline : 01452 317890
Mon - Fri / 8am - 5pm
Email : technical@eastbrookco.com