

## DATASHEET

### Image

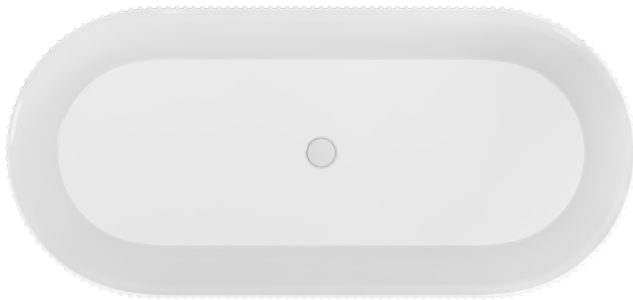

### General Information

Product:	33.0049
Description:	Sandford 1500 Freestanding Bath inc waste
Website Link:	<a href="#">(Click Here)</a>
Product Type:	Freestanding Bath
Brand:	Eastbrook Company
Colour:	White
Material:	Double skinned 4mm thick acrylic
Height (mm):	580mm
Width (mm):	740mm
Length (mm):	1495mm
Net Weight (kg):	35kg
Product Range:	Sandford

### Product Specifications

Warranty:	5 Year(s)
Water Capacity:	255L
Compatible Tap Types:	Floor or wall mounted
Pre-drilled tap holes:	No

## Drawing

Code No.: 33.0049

Dimensions: 1495x740x580 mm

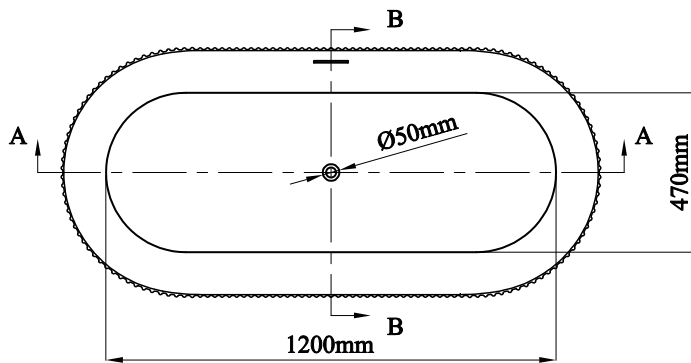
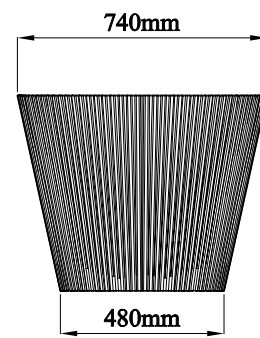
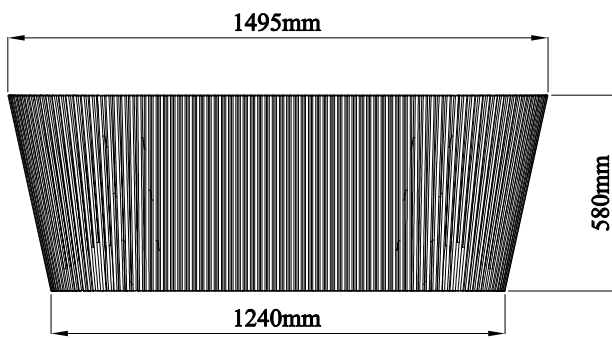

SECTION A-A

SECTION B-B

