

DATASHEET

Image



General Information

Product:	41.0632
Description:	Wendover Straight Multirail 600 x 750
Website Link:	(Click Here)
Product Type:	Towel Rail
Brand:	Eastbrook Company
Colour:	Matt Anthracite
Material:	Mild Steel
Height (mm):	600mm
Width (mm):	750mm
Net Weight (kg):	5.68kg
Product Range:	Wendover

Product Specifications

Warranty:	5 Year(s)
Supplied with fixings:	Yes
Orientation:	Horizontal
BTU $\Delta T50^{\circ}\text{C}$:	1059
BTU $\Delta T60^{\circ}\text{C}$:	1355
Watts $\Delta T50^{\circ}\text{C}$:	311
Watts $\Delta T60^{\circ}\text{C}$:	397

Drawing

Wendover Straight 600 x 750mm. Technical Drawing

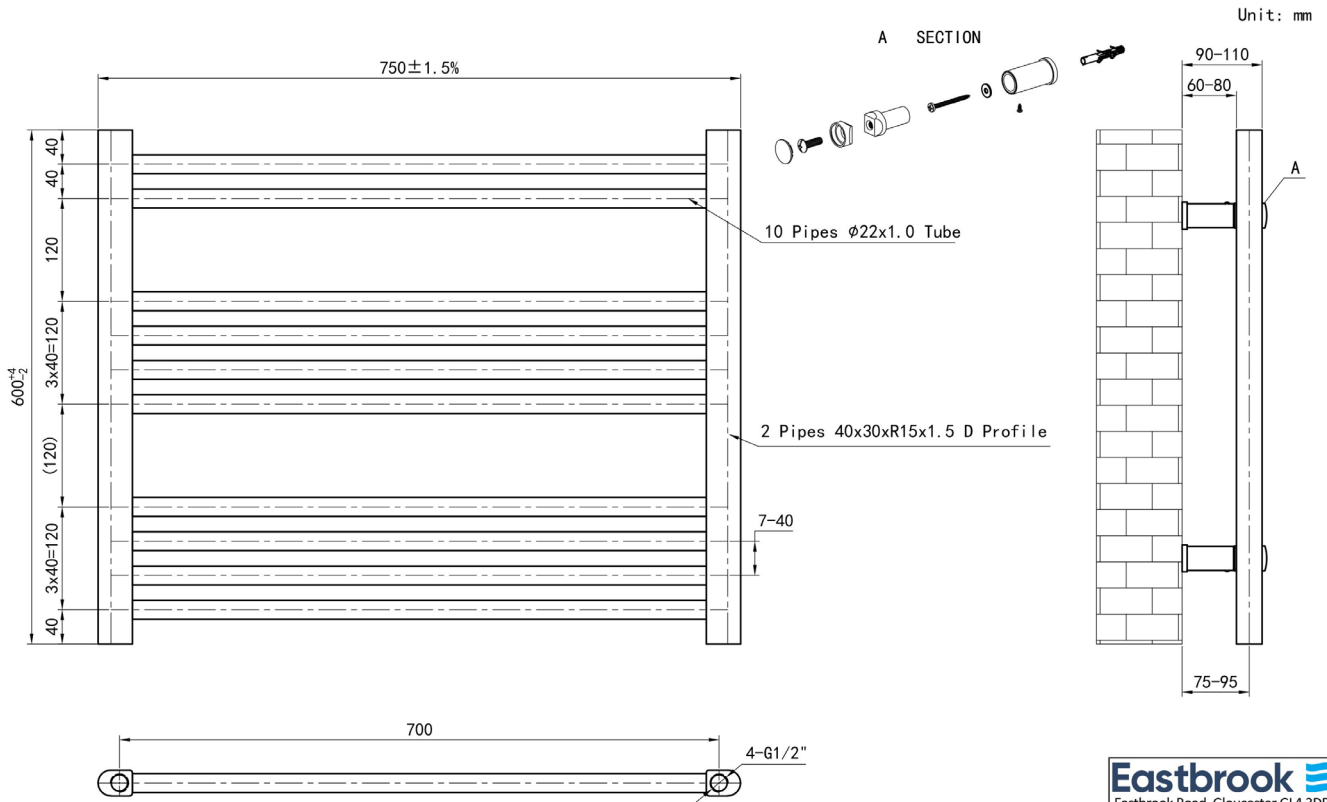

Eastbrook 
Eastbrook Road, Gloucester GL4 3DB
Technical Helpline : 01452 317890
Mon - Fri / 8am - 5pm
Email : technical@eastbrookco.com