

DATASHEET

Image



General Information

Product:	41.0803
Description:	Warrington Towel Hanger 500mm
Website Link:	(Click Here)
Product Type:	Towel Hanger
Brand:	Eastbrook Company
Colour:	Brushed Brass
Material:	Stainless Steel
Width (mm):	500mm
Net Weight (kg):	0.87kg
Product Range:	Warrington

Product Specifications

Warranty:	5 Year(s)
-----------	-----------

Drawing

Warrington Towel Hanger 500mm. Brushed Brass Technical Drawing

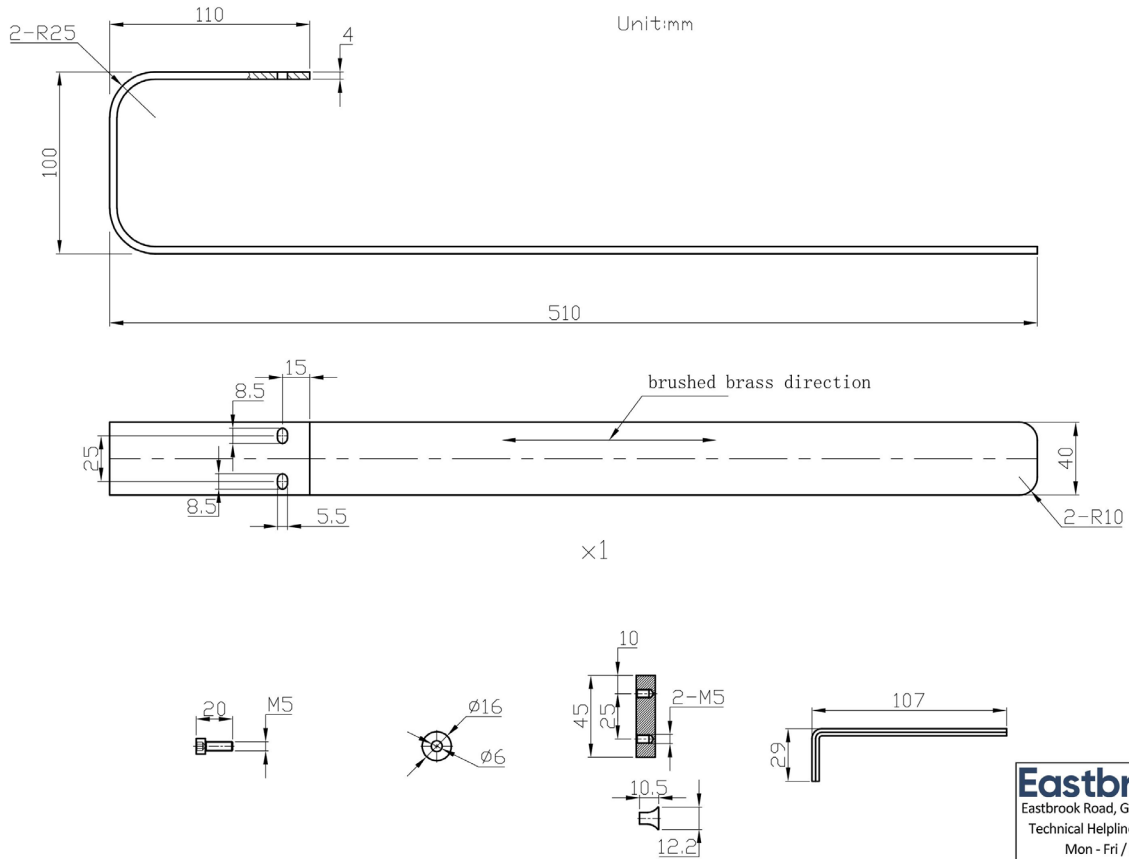

Eastbrook 
Eastbrook Road, Gloucester GL4 3DB
Technical Helpline : 01452 317890
Mon - Fri / 8am - 5pm
Email : technical@eastbrookco.com