

Towel Rail Installation

Eastbrook









- .This product must be installed by a fully qualified plumber.
- .Read the instruction sheet carefully before installation.
- .Check all the parts are enclosed as per the contents list.
- .If there are any missing parts or damage please contact your supplier immediately.







Eastbrook Road, Gloucester GL4 3DB
 Technical Helpline: 01452 317890
 email: technical@eastbrookco.com

Contents List

Tools Required

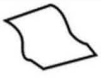

	Grub screw	4
	Bolt	4
	Blanking plug	1
	Bleed valve	1
	Spacer	4
	Wall fixing screw and plug	4
	Washer	4
	Wall support	4

	Description
	PTFE Tape
	Large Flat Screwdriver
	8mm Masonry Bit or 3mm Wood Bit
	Socket Set
	Spanner
	Clean Cloth
	electric drill
	Spirit level

Assembly

1. Select your desired installation position and ensure insert a space that the wall is sufficiently strong enough to hold the weight of the ladder rail. Solid walls are ideal but if positioning on plasterboard wall it must be fixed to timber batons.
2. Screw the blanking plug and air vent plug into the top two threads in the upright channel of ladder rail. Apply PTFE tape, use a cloth to prevent scratching when tightening with spanner.
3. Mark the wall in the required position for the brackets and drill.
4. Screw the wall support to the wall with long screw and washer supplied (use wall plug if fitting to solid wall).

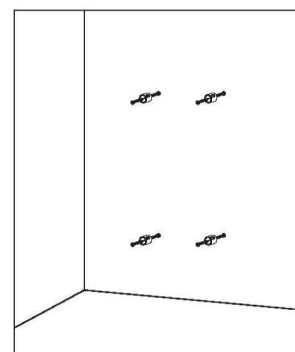
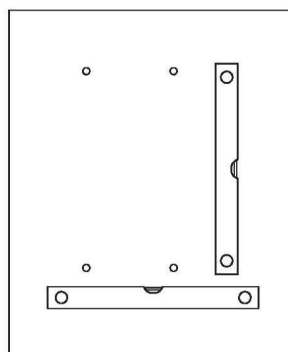
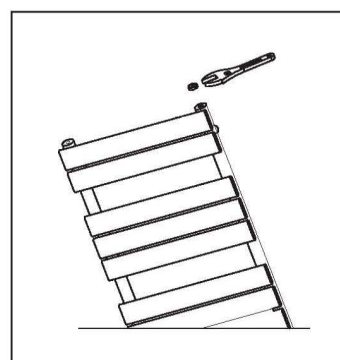

5. Fix spacer to pre-positioned tapping or rail with bolt.

6. Lift rail into place, slide spacer into wall support and secure with grub screw.

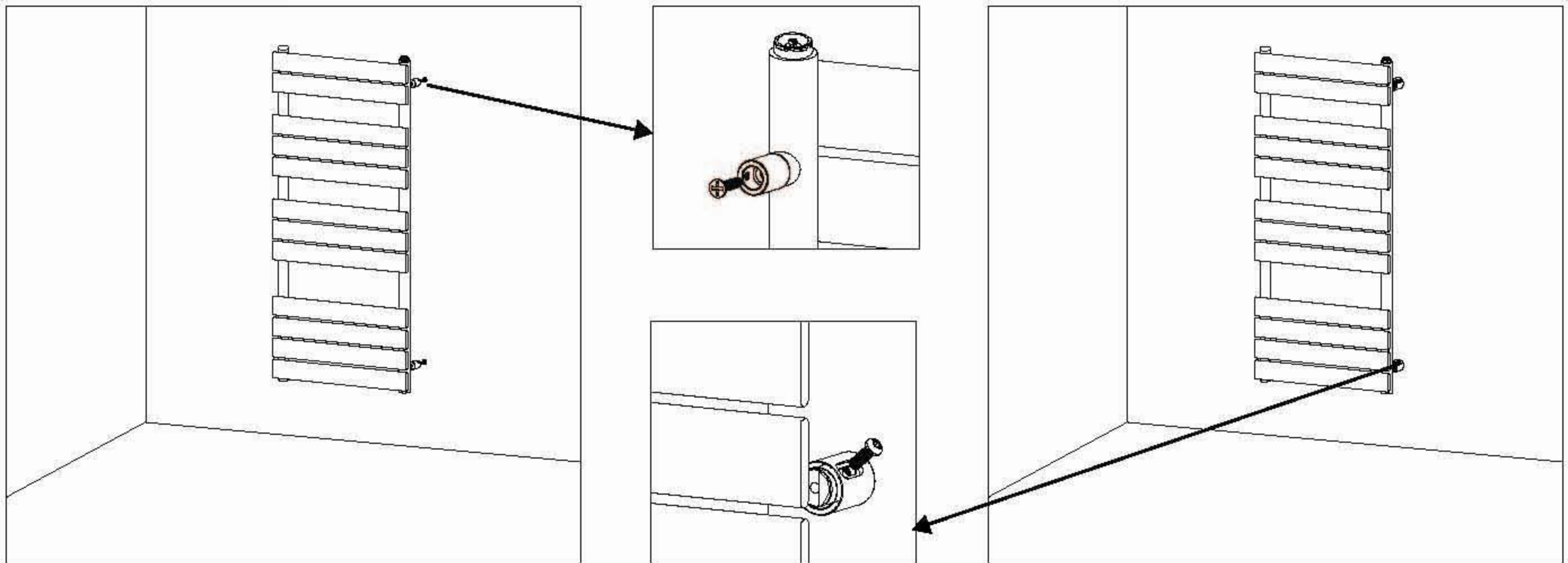

On commissioning, flush the central heating system thoroughly using a proprietary solution to ensure that aggressive substances such as fluxes and manufacturing residue, from which the internal surfaces of your towel rail can sustain irreparable damage, are removed. It is further recommended that an appropriately approved corrosion inhibitor be subsequently added to the heating system in order to protect the heated towel rail and other parts of the central heating system to promote extended operating lifespan.

Maintenance

From time to time it is advisable to wash your towel rail with warm soapy water in order to retain its original sparkle. Never use any form of abrasive cleaner.

Corrosion inhibitor must also be regularly maintained, please consult your engineer for details.

Warranty

Your heated towel rail is fully warranted for five years in respect of defective materials. This is subject to installation being carried out by a qualified engineer in accordance with good practice and corrosion inhibitors being regularly maintained.

Helpline: 01452 317890

Mon-Fri 8.00am - 5.00pm