

## Electric Radiator with Glass Front “Wi-Fi controlled Radiator”

### Instruction Manual



Product Codes : 11.0001 – 11.0002 – 11.0003  
11.0004 – 11.0005 – 11.0006

## **1. Safety & Warnings**

## **2. Technical Specifications**

## **3. Installation**

- 3.1 Freestanding Installation
- 3.2 Wall Mounting Instruction

## **4. Control Panel**

- 4.1 Power Function
- 4.2 Mode Selection
- 4.3 Temperature Selection
- 4.4 Timer Setting
- 4.5 Child Lock
- 4.6 Light off
- 4.7 Open Window Detection
- 4.8 Memory function
- 4.9 Wi-Fi Setting
- 5.0 Tilt Protection

## **5. Connecting to Wifi**

- 5.1 Downloading the App
- 5.2 Connecting to the App

## **6. Using the APP**

- 6.1 Home Overview
- 6.2 Control Interface

## **7. CLEANING AND CARE**

## **8. DISPOSAL**

Read this manual carefully before using or installation the device. Keep the manual for future reference.

 **Warning: This device must be installed by a licensed electrician.**

## 1. SAFETY & WARNINGS

- Read the manual before you use the heater. Keep the manual and ensure it stays with the heater if you give it to a new owner.
- Before use, check that the heater and all supplied accessories are complete and intact.
- The heater must be installed as per installation instructions. The heater must be plugged into a socket that meets the following requirements: AC 230V, frequency 50/60Hz.
- The heater is only suitable for indoor use. Do not use it outdoors!
- Do not leave the heater unattended during use. Keep the heater out of the reach of children: risk of burns.
- Do not use an external controller with the heater. The heater must not be set to switch on when it will be unattended.
- Do not use the heater near flammable or explosive materials: risk of fire or explosion.
- Inserting items into the protective grill of the heater is strictly prohibited: risk of electric shock
- Do not touch the metal housing as it will get hot when the heater is in use: risk of burns. Set aside some time to let the heater cool before you turn it off and store it.
- Unplug the heater if it is going to be out of use for a long time.
- Prior to each use of the electric heater, make sure it is in a good condition and intact. Do not plug in or use the heater if the casing, wire or plug are damaged.
- The heating element may be damaged if the heater is dropped or hit. Check that the element is not damaged prior to each use. Do not use the heater if the element is broken.
- Disconnect the plug from the socket when moving or cleaning the heater. When disconnecting, first turn off the switch, then unplug the plug. Do not yank the cable.
- Demolition of the electric heater without authorization is strictly prohibited. Please look for professional service personnel if the heater is damaged.
- The product is limited to home use only.
- During use, do not let bare skin touch the surface of the appliance: risk of burns.
- Do not share the heater's socket with other appliances: risk of fire due to excessive load.
- CAUTION: never cover the heater. Covering the heater risks overheating and fire.
- The heater must not be located immediately below an electrical socket-outlet. If the heater has been dropped or damaged it should not be used until it has been inspected by a qualified service center.
- Avoid the use of an extension cord as this may overheat and cause a fire risk.

- Suitable to be fitted in a bathroom / cloakroom only if it's fitted by a fully qualified electrician in accordance with BS-EN 7671 and located in a position suitable for its IP rating. Never place the heater where it may fall into a bathtub or other water receptacle.
- Children of less than 3 years should be kept away unless continuously supervised.
- Children aged from 3 years to 8 years shall only switch on/off the appliance provided that it has been placed or installed in its intended normal operating position and they have been given supervision or instruction concerning use of the appliance in a safe way and understand the hazards involved. Children aged from 3 years and less than 8 years shall not plug in, regulate and clean the appliance or perform maintenance.
- This appliance can be used by children aged 8 years and above and persons with reduced physical, sensory or mental capabilities or lack of experience and knowledge if they have been given supervision or instruction concerning use of the appliance in a safe way and understand the hazards involved. Children shall not play with the appliance. Cleaning and user maintenance shall not be made by children without supervision.
- CAUTION: some parts of this product can become very hot and cause burns. Particular attention must be given where children and vulnerable people are present. Do not leave the heater turned on when leaving your home.



**Certain parts of the heater can become extremely hot and cause burns. Avoid touching hot surfaces.**

**Extra care should be taken in areas where children and vulnerable individuals are present.**

## 2. TECHNICAL SPECIFICATIONS

Heating element	X shaped Aluminum
Voltage	230V AC / 50Hz
Power	1000/1500/2000W
Temperature setting	5–50 °C
IP rating	IP24
Appliance class	Class I
Power cable length	1.5m
WiFi frequency (2.4G band) Operation frequency Max RF power transmitted	2400-2483.5MHz 17.21dBm (52.6mW) < 20dBm (100mW)

## 3. INSTALLATION

Before installing, check that all parts are complete and the product is intact.

If you want to use the electric heater freestanding, please fit with the feet provided with the heater, following the instructions below. Make sure the heater is mounted on a level, stable and clean surface.

### 3.1 Freestanding Installation

1. Put the product upside down on a soft cotton cloth or carpet.
2. Fix the feet to the base of the heater using the screws provided. Line up the holes in the base with the holes in feet, put the screws through the holes and tighten with a screwdriver.

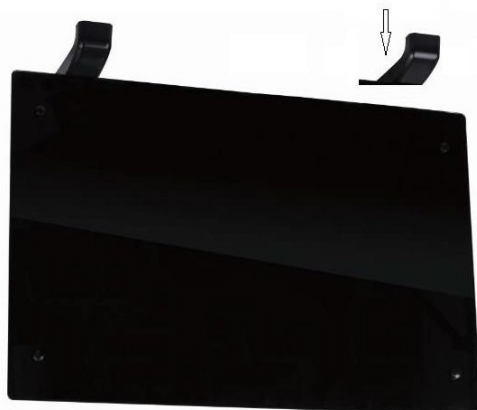

### 3.2 Wall Mounting Instructions

#### 3.2.1. Hook Type Bracket

Take out 4 brackets, 6 expansion screws and 6 screws out from the box, and fix 2 brackets onto the wall according to the distances between holes of the bracket, as depicted in the picture below.

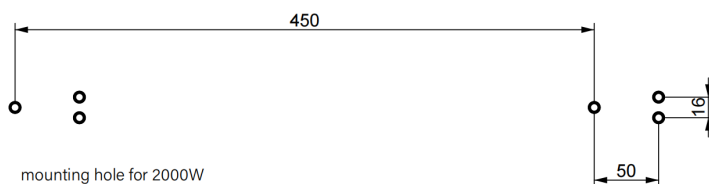
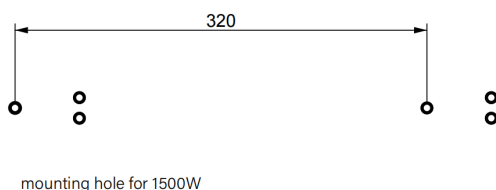
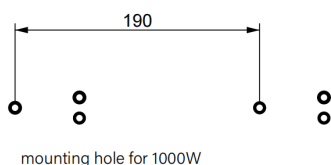

unit:mm

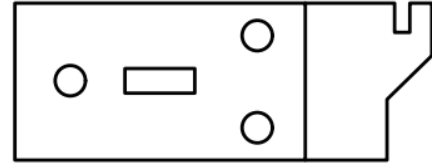
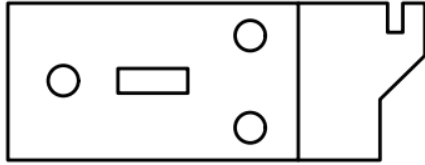

3.2.2. Fix 2 brackets onto the bottom of products, as depicted in the picture below.

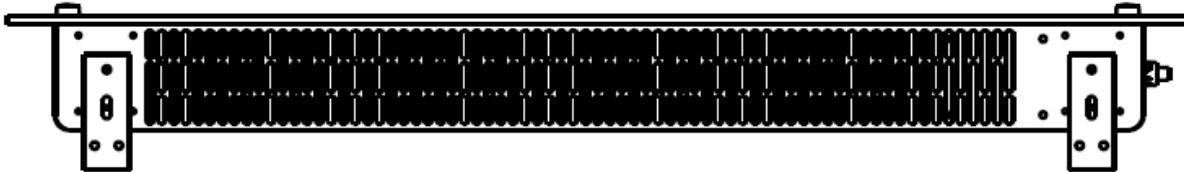

3.2.3. Hold the side of the product, look at the position of the wall hole of the rear cover, and slide the wall to the top of the slot, that is, the installation of the wall is completed, as depicted in the picture below.

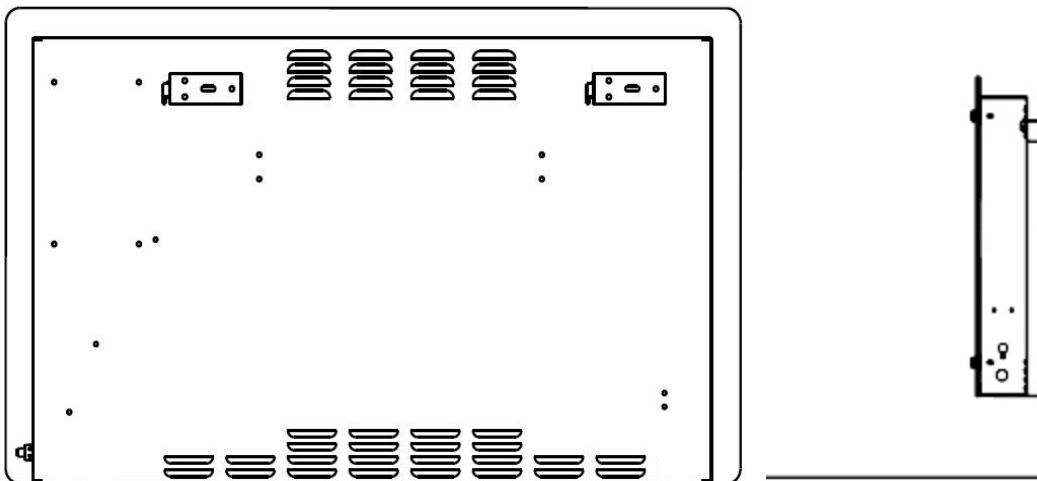

## NOTES



Prior to the drilling, make sure there is no cable or other pipelines on the wall to avoid damage. Remember that the screws on the wall shall be fixed and firm to ensure the safety installation of the electric heater on the wall. Please note the safe distance mentioned below.

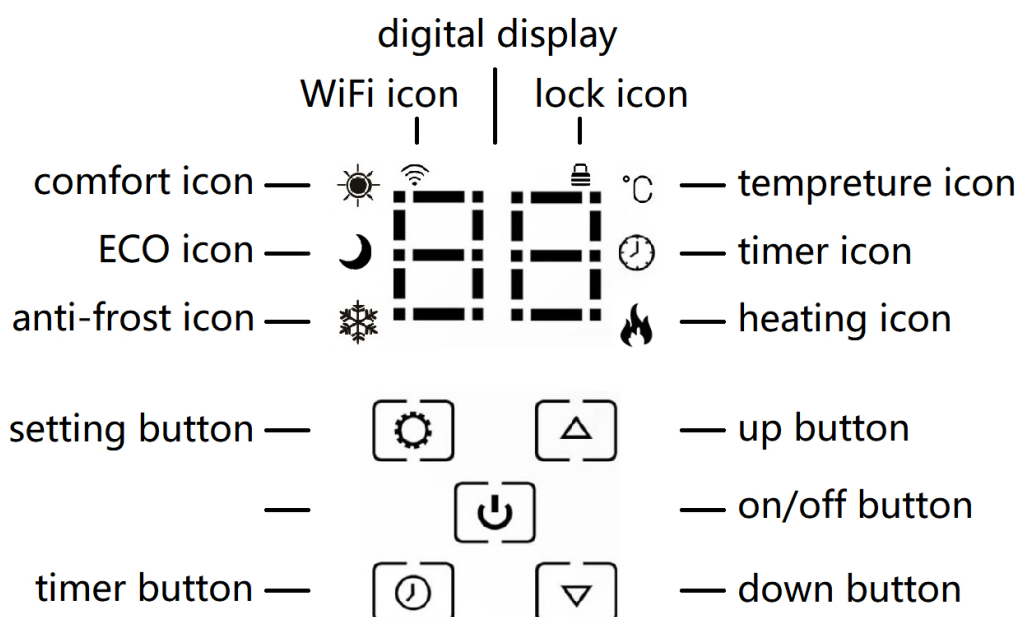

- During installation, the heater must be maintained sufficiently safe distance from combustible materials and gas and away from water.
- During wall-hanging installation, keep the installation height from the ground greater than 15 cm. Hanging-type heater shall be no less than 50 cm away from the ceiling.

## 4. CONTROL PANEL











## How to use the heater

### 4.1 Power Function





On/Off setting: The heater will beep as it power on, the heater enter standby mode and will not heat. the digital display  shows the current ambient temperature, Press the  button to switch between standby and heating modes.

### 4.2 Mode Selection

- To initiate heating, press the  button. the product automatically enters comfort mode, Comfort icon is on , the heating icon  is on or off depending on the ambient temperature. The initial setting temperature is 25 degrees, and when the ambient temperature is above 25 degrees, it does not light up. The heater does not heat, but when it is below 25 degrees, it does light up. The heater heats up.
- Press the  to cycle through the modes: Comfort mode , ECO mode , and Anti-frost mode . Full power in comfort mode, half power in ECO mode, and full power in Anti-frost mode. The heating icon  is on when the product heats and is off when doesn't heat.
- Comfort mode is 100% output (2000 Watts), ECO mode is 50% output (1000 Watts), Anti-Frost mode temperature is 5°C. (calculated for the 2000W model – for lower output models, please use the related powers)





Note: The memory function: you can control your heater by your smartphone remotely if you are connected to a network and have a stable internet connection.

### 4.3 Temperature Selection





Press the  and  to adjust the temperature. when the digital  and temperature icon  flash.

- Comfort mode temperature range: from 5°C to 50°C.
- ECO mode temperature range: from 5°C to 50°C.
- Anti-frost mode is 5°C, when the ambient temperature is lower than 5°C, the heater will work with full power. When the ambient temperature is higher than 5°C, the heater will stop heating.

### 4.4 Timer Setting

Press the  button, when the digital  and timer  flash, then press the  buttons to adjust the time, Timer range is 1 – 24 hours. After the time is set, the timer icon  remains on and goes off after the timer is set.



### 4.5 Child Lock

Press and hold the  button 3 seconds to switch on the child lock function. the lock icon  appear on the screen and all the buttons will be locked. to release, press and hold the  the button,  icon will disappear, indicating that all the buttons can be used again, and all button functions are restored.

### 4.6 Light Off

After any setting is completed for 30 seconds, the light of display will turn half on. Press and hold the button  3 seconds turns off all lights. Touch any button, the light will light up same as before closing display.

### 4.7 Open Window Detection

To active the open window detection, Press and hold the  button for 3s, The open window icon **OP** appear on the screen, Press and hold the  button 3s to close the open window function, In all heating modes (Comfort mode; Eco mode;), when opening the room window, the room temperature drops 4 degrees in 20 minutes, the heater automatically stops heating, the **OP** icon will displays on the screen and flash. If you need to resume heating work, you need to unlock (if locked), and press the button restore to the working mode before the window was opened.

### 4.8 Memory function

After switching on or off the machine, or the product is powered on and off. The product comes with program memory function.

### 4.9 Wi-Fi Settings

In power on status, Press and hold the  button for 3 seconds, the WiFi icon flashes and automatically enters the distribution network state. After the distribution network is successfully connected. The Wi-Fi indicator light remains on.

## 5.0 Tilt Protection

As a safety feature, this radiator is fitted with a tilt protection function that automatically places the radiator into standby mode if the appliance fell down.

When the appliance is returned to an upright position, normal operation will then be resumed.

# 5. CONNECTING TO WIFI

## 5.1 Downloading the App

Download the APP onto your smart phone. You can find the app by scanning the QR code below or searching "SMARTLIFE" in the Google Play or Apple app store. Install and follow the app's instructions to create an account.



NOTE - The SMARTLIFE or TUYA app is a constantly evolving third party system. This guide was correct at time of printing but may differ slightly from future versions. The app is designed to work on Android or iOS but older software versions may affect app presentation and performance.

## 5.2 Connecting to the App

**(Now only 2.4G Wi-Fi is supported. Please make sure your Wi-Fi is 2.4.)**

- Method 1: Press "Add" button in the upper right corner(in this case, you need to keep your phone Bluetooth on).Then enter the Wi-Fi password . Press "next" to start connecting.

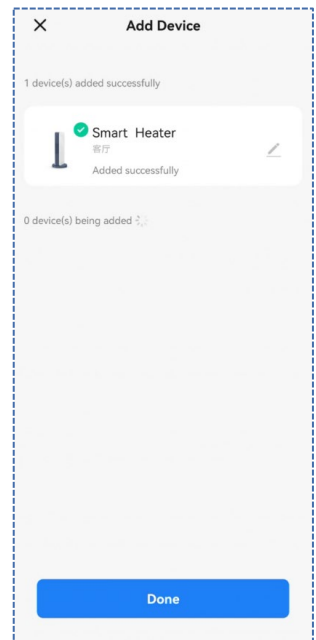
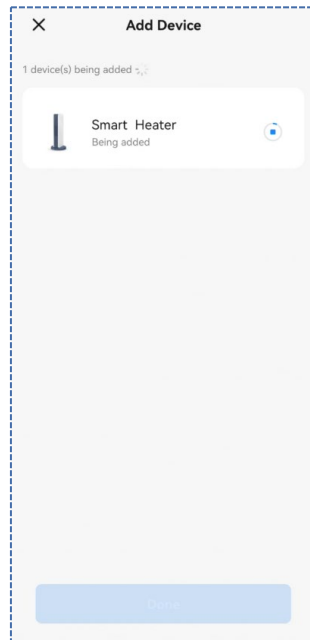
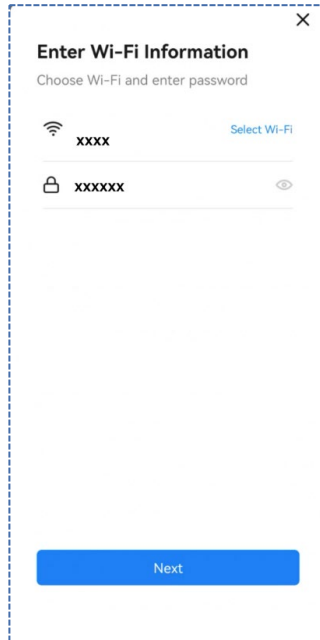
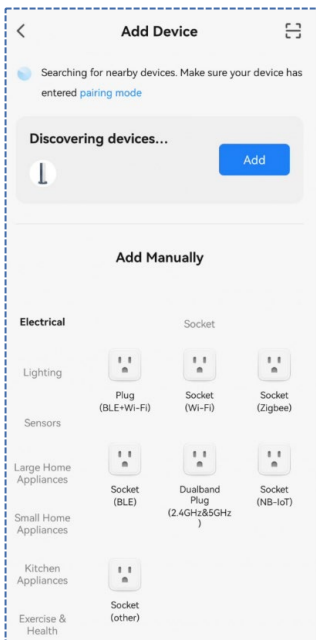

- Method 2: To add the heater to the app, press to switch on the heater. Press and hold the button for 3 seconds enter WiFi connection mode . The heater is connecting now when the icon flashing.
- Once the icon is flashing, go to the app and press Add Device. Select the device type (Small Appliances > Heater) and confirm that the indicator is flashing. You will then be prompted to enter your WiFi password. This allows the app to find your heater using your WiFi.

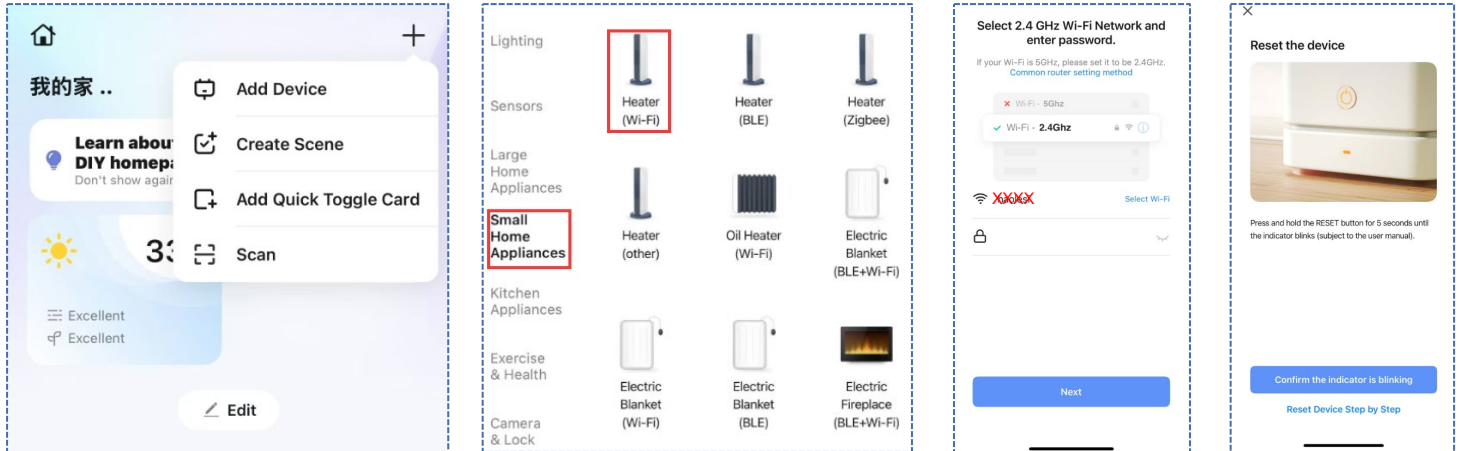

- The app will display device is connecting now.

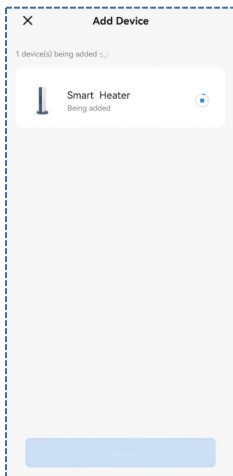

**NOTE** : if the heater is failing to connect, press and hold the for three further seconds. It will switch to secondary connection mode.

- The heater will beep and display solid icon when the device is connected.

The app will confirm that the heater has been added. You can now name the device, share it with family members, or proceed to scheduling your heating.

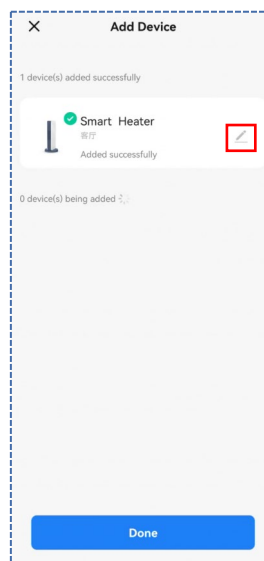

## 6. USING THE APP

### 6.1 Home Overview

You can use the Smart life app to control multiple devices. All devices are displayed on the home screen with their status.

Possible statuses:

- Turned On – Device is in heating mode.
- Turned Off – Device is in standby mode. It can be controlled by the app.
- Offline (device is turned off at wall / rocker switch)

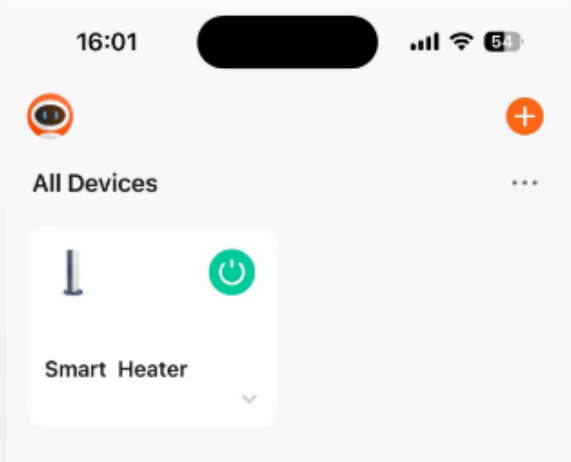

When the heater is online, tap the device name to go to the control interface.  
 Note: when the heater is offline, you will not be able to control it with the app.

### 6.2 Control Interface

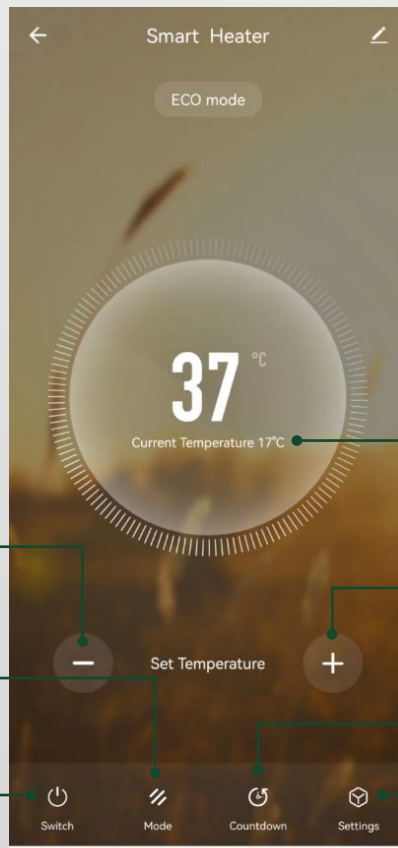

Decrease temperature

Current Room temperature

Choose mode

Increase temperature

Power ON/OFF

Countdown/Timer

Settings

## 6.3 Choose Mode



Image 1

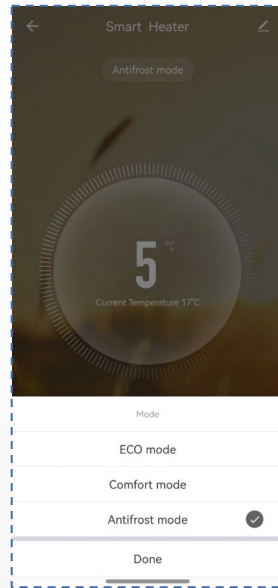

Image 2

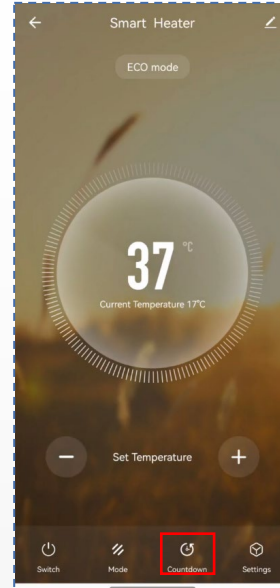

Image 3

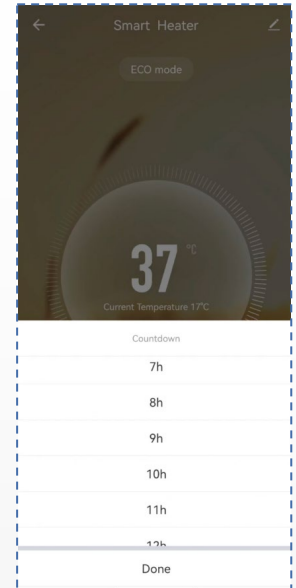

Image 4

Tap the mode button on the interface to choose mode. The three options correspond to the three modes on the control panel. ECO, Comfort, Antifrost, as show in Image 1 and Image 2.

## 6.4 Choose Countdown/Timer

Tap the Countdown button on the interface to select the timer period from 1 to 24 hours, in steps of 1 hour. as show in Image 3 and Image 4.

## 6.5 Settings

### 6.5.1 Child Lock

Tap on “Settings”, Select “Child Lock” Use the toggle switch to lock or unlock the heater,  displays on the screen when the device is locked,as shown in Image 5 and Image 6.



Image 5

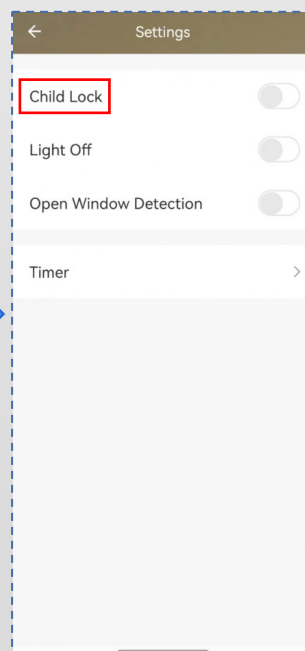

Image 6

### 6.5.2 Light Off

Tap on “Settings”, Select “Light Off” Use the toggle switch to Turn off the screen or not. as shown in Image 7 .

### 6.5.3 Open Window Detection

Tap on “Settings”, Select Open Window Detection” Use the toggle switch to activate the opened window function or not. as shown in Image 7 .

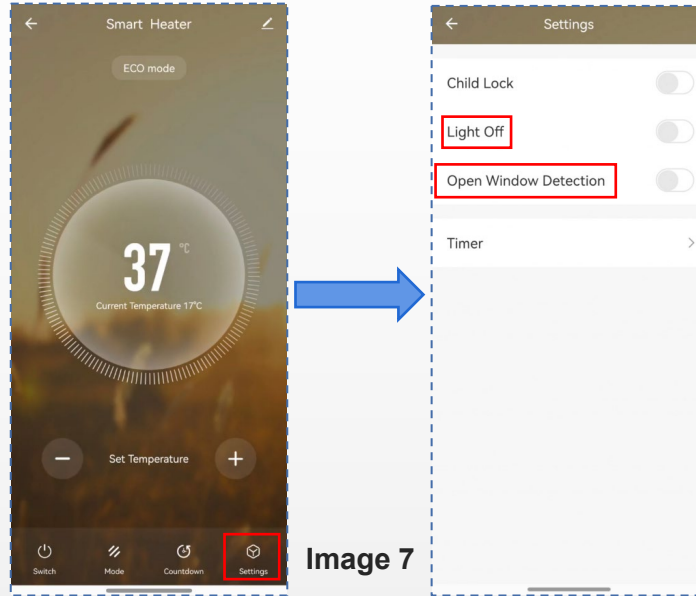

Image 7

### 6.5.4 Timer

- 1) Tap on “Settings”, Select “Timer” as shown in Image 8 - Image 11.
- 2) You can add the weekly schedule and set the desired timer and tap the “Save” button in the top right corner to save this setting for “ON or OFF” weekly timer operation.
- 3) These schedule can be temporary, or they can be recurring, so the heater switches on at the same time every week. You can set an unlimited number of schedule, switching the heater on and off across the week.
- 4) For every schedule, you must set a start time. Then, choose whether you want it to repeat. Select “Only Once” if you just want to set a timer for now. If you want the schedule to repeat, select which days you want it to occur. Finally, choose whether you want the heater to switch on or off. Make sure confirm your settings at every stage and press save to keep the schedule.



Image 8

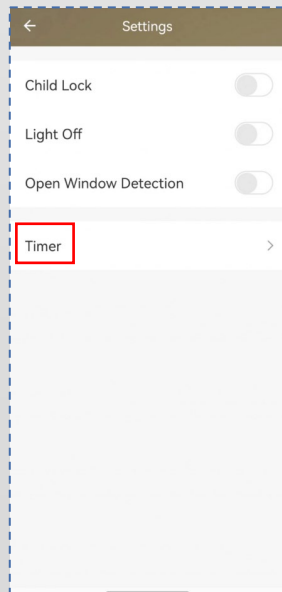

Image 9

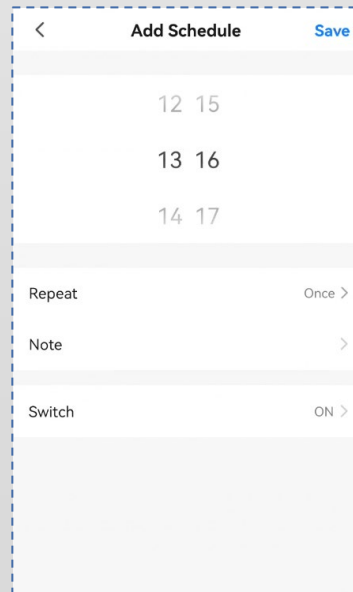

Image 10

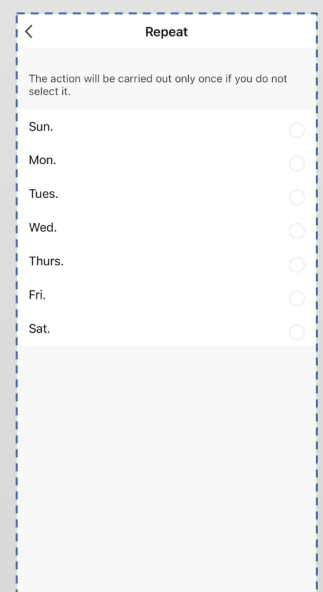

Image 11

## 7. CLEANING AND MAINTENANCE

### Maintenance

Always isolate the power to the appliance and let it completely cool before any maintenance. Use a vacuum cleaner to remove dust on grilles. Clean the outside of the unit with a damp cloth and then dry it with a dry cloth. Never immerse the unit in water, nor let water drip into the unit.

### Storing

Always disconnect the appliance, let it completely cool and clean it before storing. If you do not use the device for a long period, put back the unit and the instruction manual to the original carton and store in a dry and ventilated place. Do not place any heavy items on top of carton during storing as this may damage the appliance.

## 8. DISPOSAL



In accordance with WEEE Directive 2012/19/EU, the icon with the crossed-out waste bin on electrical or electronic equipment stipulates that this equipment must not be disposed of with household waste at the end of its life. You will find collection points for free return of waste electrical and electronic equipment in your vicinity. The addresses can be obtained from your local authority.

The separate collection of waste electrical and electronic equipment enables the re-use, recycling and other forms of recovery of waste equipment, and prevents any negative effects for the environment or human health.