

BATH INSTALLATION GUIDE

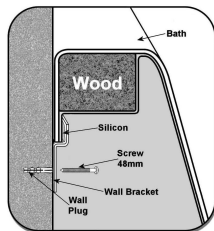

*** Refer to height of panel chosen.**

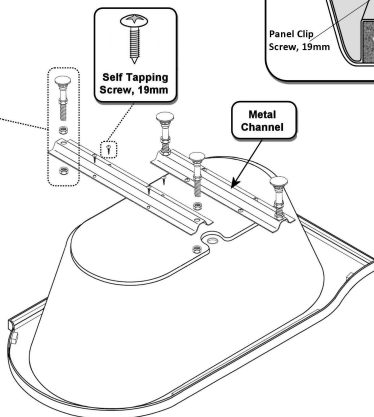
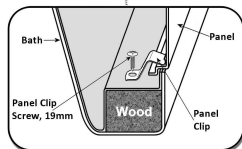
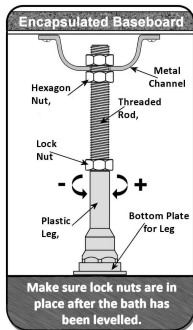
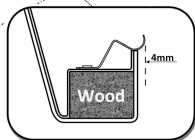
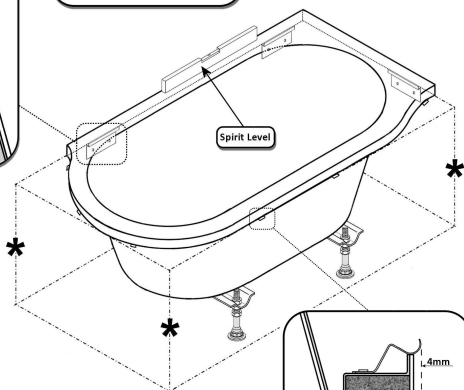

AK-11-C

Don

Advantage
Panel Fixing Instructions

Screw the clips to the blocks underneath the bath roll. Screw locations are pre-drilled.

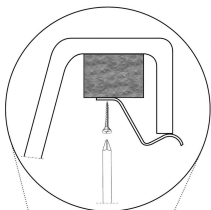

Your panel is supplied to fit but if the walls are uneven or the walls are tiled, making the panel too long, you may have to cut the ends of the panel to fit. This is done using a fine-toothed hack-saw.

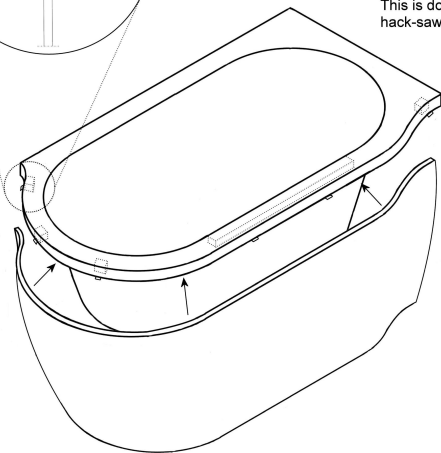

Insert the panel into the clip starting at one end of the bath and continue all the way round to the other end.

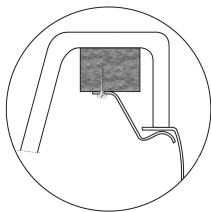

LP-UK-0061