

DATASHEET

Image



General Information

Product:	25.7021
Description:	Keynsham Type 22 Panel Radiator 600 x 1200 with Lined Designer Cover
Website Link:	(Click Here)
Product Type:	Radiator
Brand:	Eastbrook Company
Colour:	Gloss White
Material:	Mild Steel
Height (mm):	600mm
Width (mm):	1200mm
Net Weight (kg):	6kg
Product Range:	Keynsham Compact Panel

Product Specifications

Warranty:	10 Year(s)
BTU $\Delta T50^{\circ}\text{C}$:	6760
BTU $\Delta T60^{\circ}\text{C}$:	8508
Watts $\Delta T50^{\circ}\text{C}$:	1980
Watts $\Delta T60^{\circ}\text{C}$:	2495

Drawing

Keynsham Lined Designer Cover - Type 22
Technical Drawing

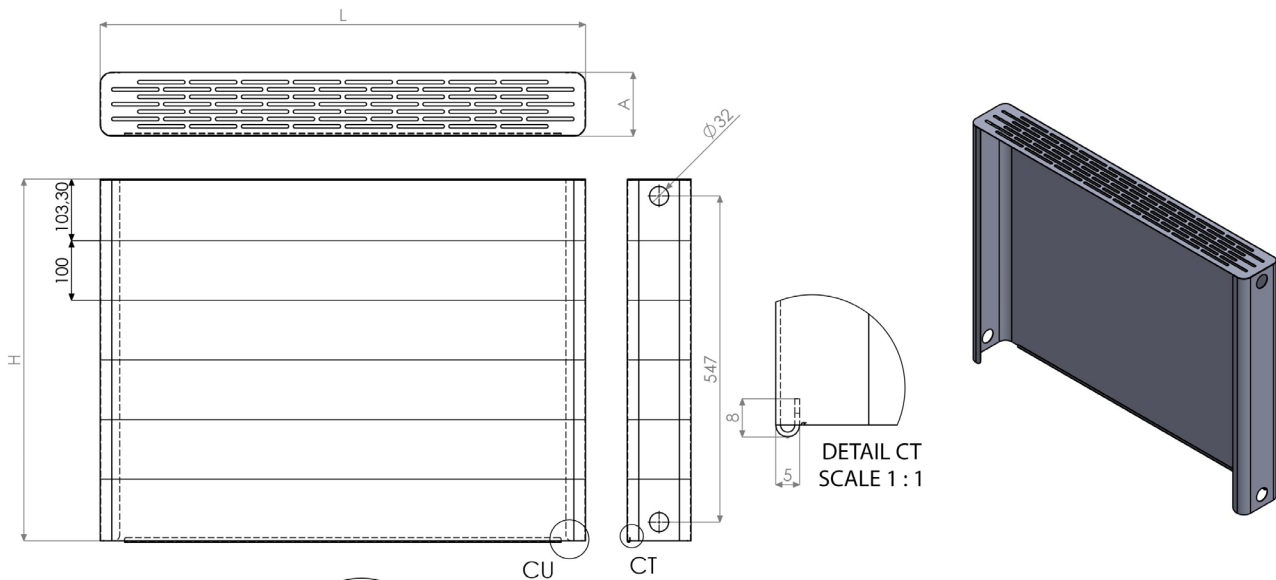

	L	H	A
600x400	414	606.6	107.1
600x500	514		
600x600	614		
600x800	814		
600x1000	1014		
600x1200	1214		

Eastbrook 
 Eastbrook Road, Gloucester GL4 3DB
 Technical Helpline : 01452 317890
 Mon - Fri / 8am - 5pm
 Email : technical@eastbrookco.com