

1312-00 - M-Frame Base

| REVISION HISTORY | | | | |
|------------------|-----|-------------|----------|----------|
| ZONE | REV | DESCRIPTION | DATE | APPROVED |
| All | 1 | Released | 2/4/2019 | RLC |

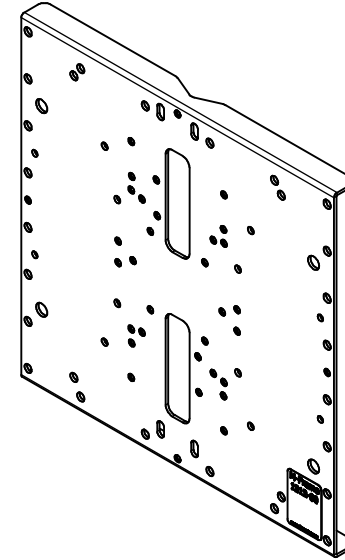

ISOMETRIC VIEW

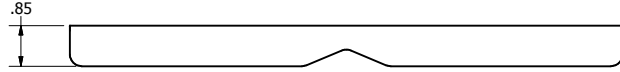
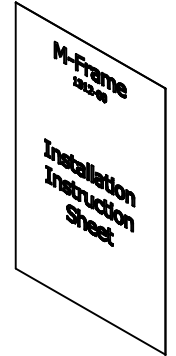
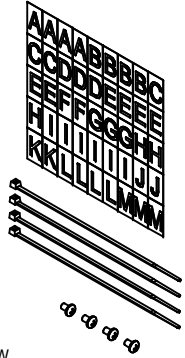

- NOTES:**
- Material: .090" Aluminum
 - Finish: Brushed
 - Mounting Holes to Match Most Manufacturers Mounting Plates
- Includes:**
- M-Frame Base
 - Mounting Screws
 - Cable Ties
 - Letter/Number Set
 - Installation Instructions

| | | | |
|--|------------------------|------------------|--|
| Oberon, Inc. - 1315 S. Allen St. - State College, PA 16801 | | | |
| TITLE M-Frame | | | |
| SIZE C | DWG NO 1312-XXX-XXX | DATE 2/1/2019 | |
| SCALE | SHEET 1 OF 7 | | |

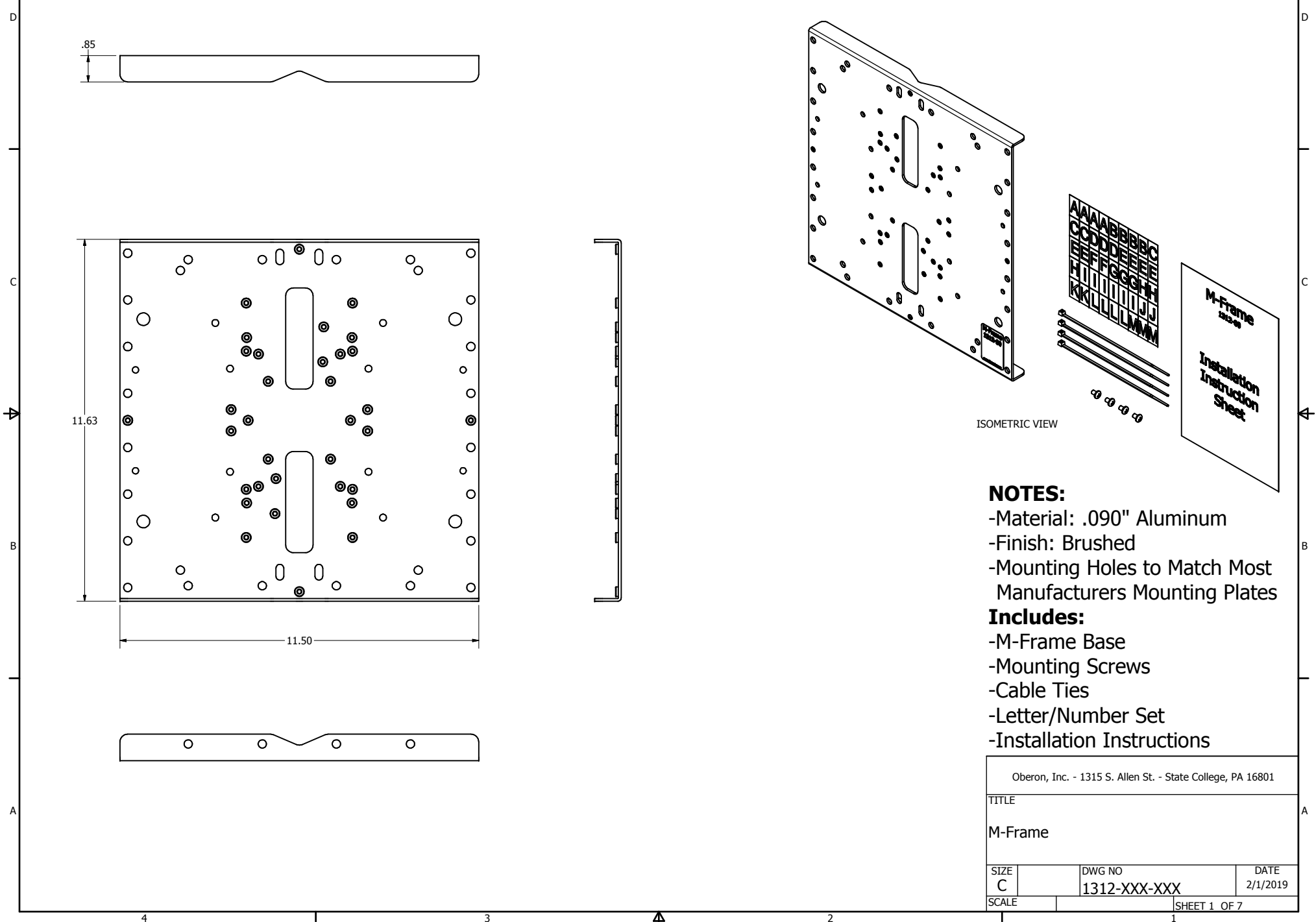
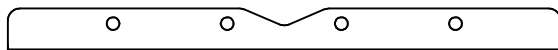
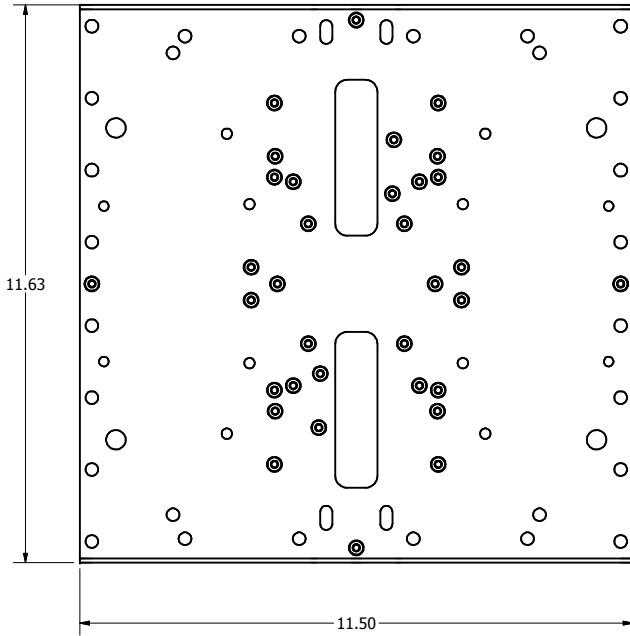

39-1312-AM1 - Omnidirectional Antenna Mounting Kit

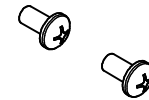
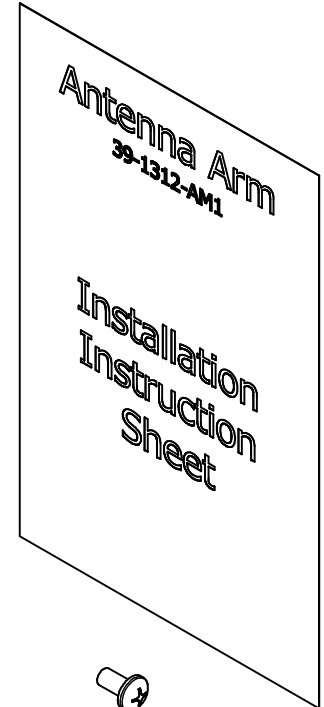
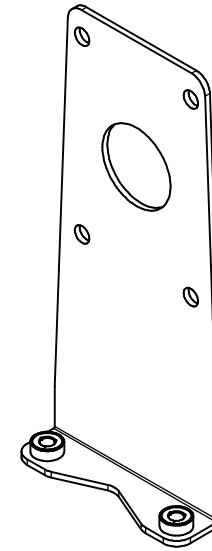
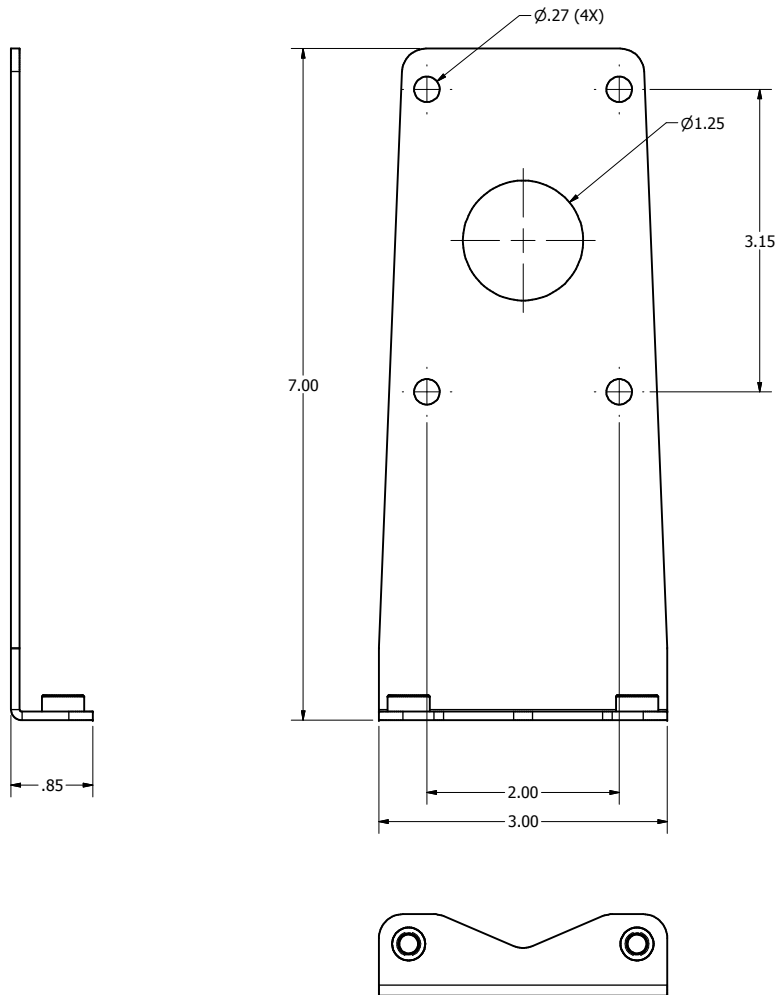

- NOTES:**
- Material: .090" Aluminum
 - Finish: Brushed
- Includes:**
- Mounting Bracket
 - Mounting Screws
 - Installation Instructions

| | | |
|--|------------------------|------------------|
| Oberon, Inc. - 1315 S. Allen St. - State College, PA 16801 | | |
| TITLE M-Frame | | |
| SIZE C | DWG NO 1312-XXX-XXX | DATE 2/1/2019 |
| SCALE | SHEET 2 OF 7 | |

39-1312-AM2 - Omnidirectional Pipe Antenna Mounting Kit

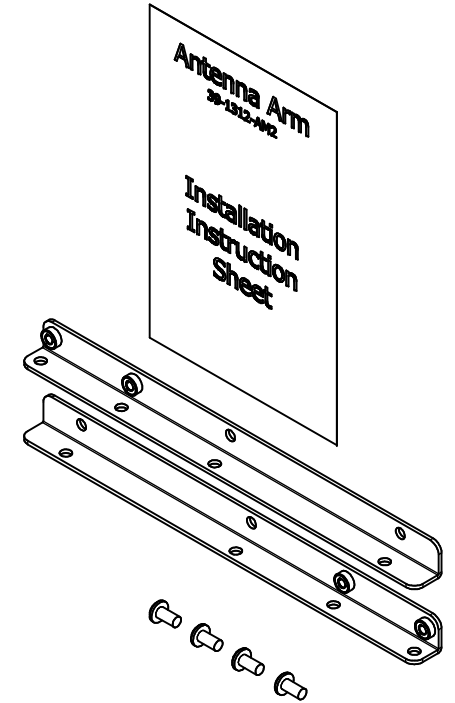
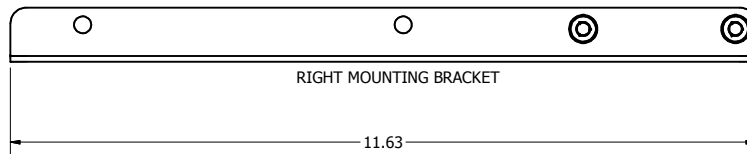
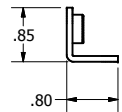
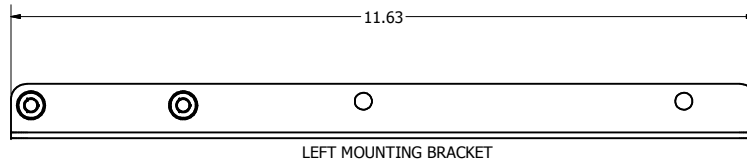
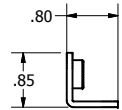

- NOTES:**
- Material: .090" Aluminum
 - Finish: Brushed
- Includes:**
- Left & Right Mounting Brackets
 - Mounting Screws
 - Installation Instructions

| | | | |
|--|------------------------|------------------|--|
| Oberon, Inc. - 1315 S. Allen St. - State College, PA 16801 | | | |
| TITLE M-Frame | | | |
| SIZE C | DWG NO 1312-XXX-XXX | DATE 2/1/2019 | |
| SCALE | SHEET 3 OF 7 | | |

39-1312-AM3 - Patch Antenna Mounting Kit

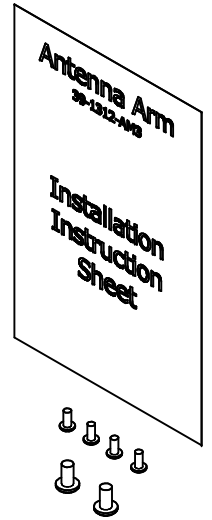
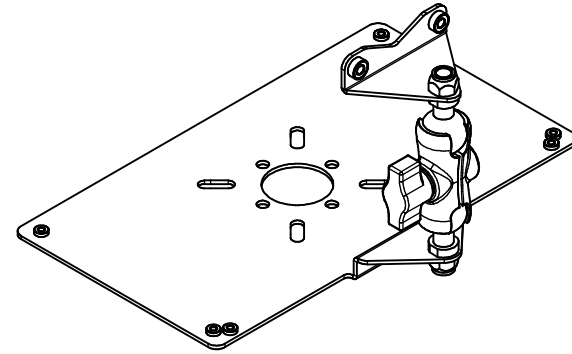
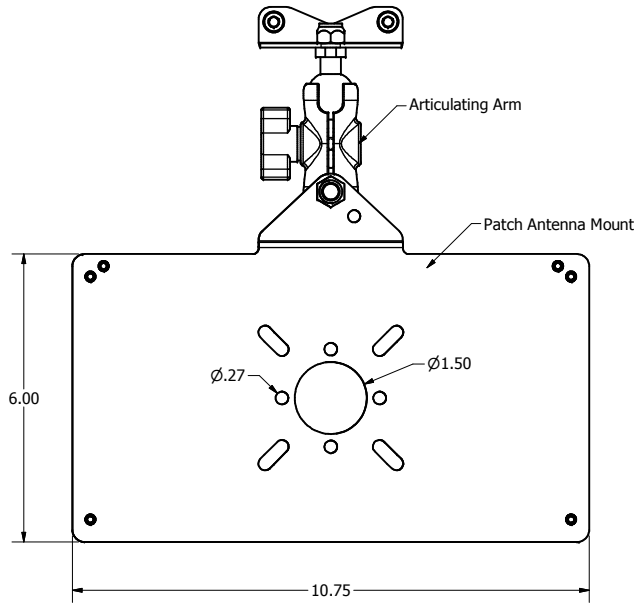
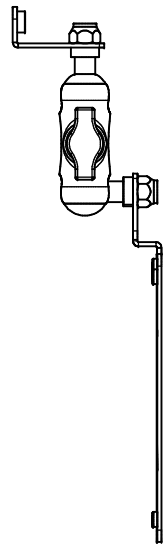

- NOTES:**
- Material: .090" Aluminum
 - Finish: Brushed
- Includes:**
- Mounting Bracket w/Articulating Arm
 - Mounting Screws
 - Installation Instructions

| | | | |
|--|--------------|----------|--|
| Oberon, Inc. - 1315 S. Allen St. - State College, PA 16801 | | | |
| TITLE | | | |
| M-Frame | | | |
| SIZE | DWG NO | DATE | |
| C | 1312-XXX-XXX | 2/1/2019 | |
| SCALE | SHEET 4 OF 7 | | |

39-1312-RAB - Right Angle Mounting Bracket Kit

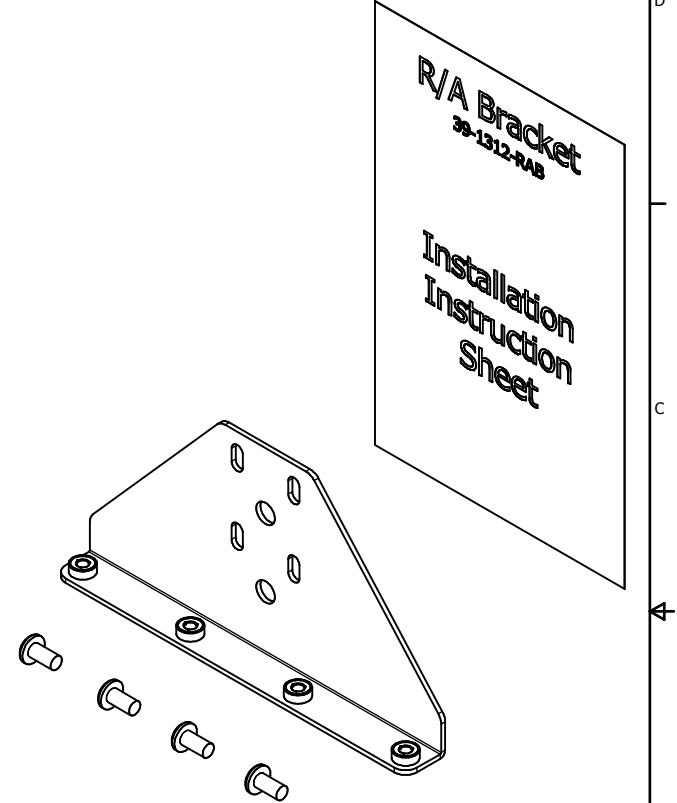
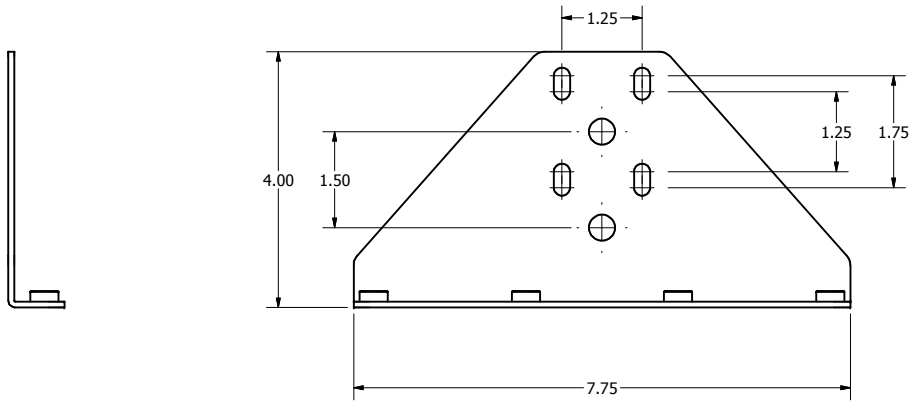

- NOTES:**
- Material: .090" Aluminum
 - Finish: Brushed
- Includes:**
- Right Angle Mounting Bracket
 - Mounting Screws
 - Installation Instructions

| | | | |
|--|------------------------|------------------|--|
| Oberon, Inc. - 1315 S. Allen St. - State College, PA 16801 | | | |
| TITLE M-Frame | | | |
| SIZE C | DWG NO 1312-XXX-XXX | DATE 2/1/2019 | |
| SCALE | SHEET 5 OF 7 | | |

Hardware Kits

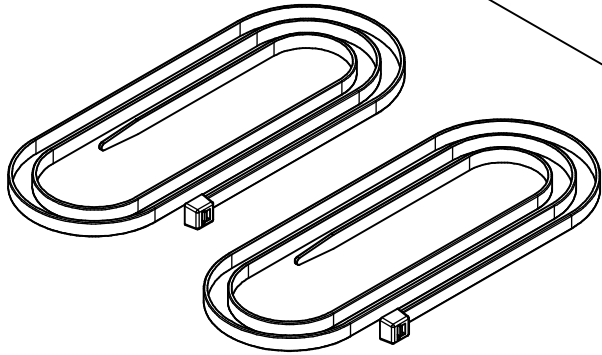
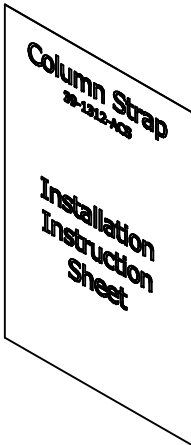

39-1312-ACS - Adjustable Column Strap Kit

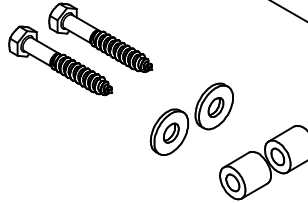
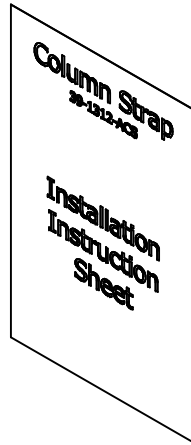

39-1312-CWS - Cement Wall Anchor Kit

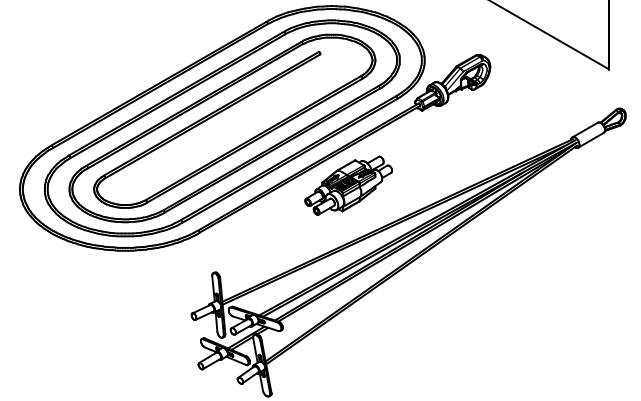
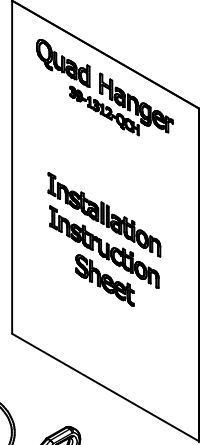

39-1312-QCH - Quad Cable Hanger Kit

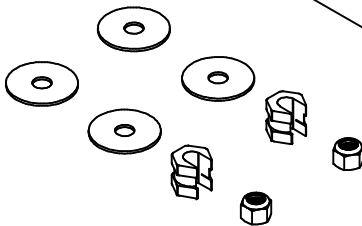
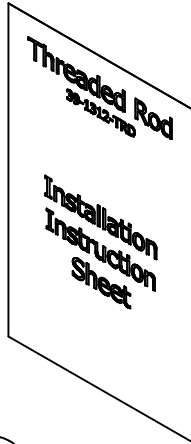

39-1312-TRD - Threaded Rod Kit

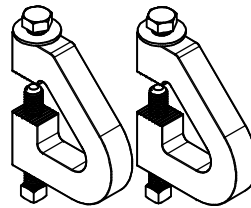
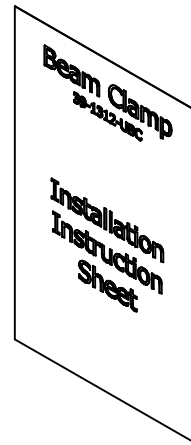

39-1312-UBC - Universal Beam Clamp Kit

| | | |
|--|--------------|----------|
| Oberon, Inc. - 1315 S. Allen St. - State College, PA 16801 | | |
| TITLE | | |
| M-Frame | | |
| SIZE | DWG NO | DATE |
| C | 1312-XXX-XXX | 2/1/2019 |
| SCALE | SHEET 6 OF 7 | |

M-Frame Model Number Look-Up Table

*NOTE - All model numbers include M-Frame base plus antenna mount / mounting option hardware kit specified below:

| M-FRAME LOOK-UP TABLE | | |
|-----------------------|---------------------------------------|---|
| MODEL NUMBER | ANTENNA MOUNT | MOUNTING OPTION HARDWARE KIT |
| 1312-00-ACS | N/A | 39-1312-ACS - Adjustable Column Strap Kit |
| 1312-00-CWA | N/A | 39-1312-CWS - Cement Wall Anchor Kit |
| 1312-00-QCH | N/A | 39-1312-QCH - Quad Cable Hanger Kit |
| 1312-00-TRD | N/A | 38-1312-TRD - Threaded Rod Kit |
| 1312-00-UBC | N/A | 39-1312-UBC - Universal Beam Clamp Kit |
| 1312-AM1-ACS | 39-1312-AM1 - Antenna Mount | 39-1312-ACS - Adjustable Column Strap Kit |
| 1312-AM1-CWA | 39-1312-AM1 - Antenna Mount | 39-1312-CWS - Cement Wall Anchor Kit |
| 1312-AM1-QCH | 39-1312-AM1 - Antenna Mount | 39-1312-QCH - Quad Cable Hanger Kit |
| 1312-AM1-TRD | 39-1312-AM1 - Antenna Mount | 38-1312-TRD - Threaded Rod Kit |
| 1312-AM1-UBC | 39-1312-AM1 - Antenna Mount | 39-1312-UBC - Universal Beam Clamp Kit |
| 1312-AM2-ACS | 39-1312-AM2 - Antenna Mount | 39-1312-ACS - Adjustable Column Strap Kit |
| 1312-AM2-CWA | 39-1312-AM2 - Antenna Mount | 39-1312-CWS - Cement Wall Anchor Kit |
| 1312-AM2-QCH | 39-1312-AM2 - Antenna Mount | 39-1312-QCH - Quad Cable Hanger Kit |
| 1312-AM2-TRD | 39-1312-AM2 - Antenna Mount | 38-1312-TRD - Threaded Rod Kit |
| 1312-AM2-UBC | 39-1312-AM2 - Antenna Mount | 39-1312-UBC - Universal Beam Clamp Kit |
| 1312-AM3-ACS | 39-1312-AM3 - Antenna Mount | 39-1312-ACS - Adjustable Column Strap Kit |
| 1312-AM3-CWA | 39-1312-AM3 - Antenna Mount | 39-1312-CWS - Cement Wall Anchor Kit |
| 1312-AM3-QCH | 39-1312-AM3 - Antenna Mount | 39-1312-QCH - Quad Cable Hanger Kit |
| 1312-AM3-TRD | 39-1312-AM3 - Antenna Mount | 38-1312-TRD - Threaded Rod Kit |
| 1312-AM3-UBC | 39-1312-AM3 - Antenna Mount | 39-1312-UBC - Universal Beam Clamp Kit |
| | | |
| MODEL NUMBER | MOUNTING OPTION | MOUNTING OPTION HARDWARE KIT |
| 1312-RAB-ACS | 39-1312-RAB - Right Angle Bracket Kit | 39-1312-ACS - Adjustable Column Strap Kit |
| 1312-RAB-CWA | 39-1312-RAB - Right Angle Bracket Kit | 39-1312-CWS - Cement Wall Anchor Kit |
| 1312-RAB-UBC | 39-1312-RAB - Right Angle Bracket Kit | 39-1312-UBC - Universal Beam Clamp Kit |

| | | |
|--|--------------|----------|
| Oberon, Inc. - 1315 S. Allen St. - State College, PA 16801 | | |
| TITLE | | |
| M-Frame | | |
| SIZE | DWG NO | DATE |
| C | 1312-XXX-XXX | 2/1/2019 |
| SCALE | SHEET 7 OF 7 | |