

# 1312-00 - M-Frame Base

| REVISION HISTORY |     |             |          |          |
|------------------|-----|-------------|----------|----------|
| ZONE             | REV | DESCRIPTION | DATE     | APPROVED |
| All              | 1   | Released    | 2/4/2019 | RLC      |

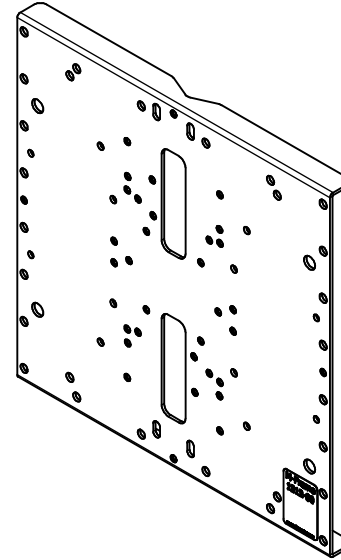

ISOMETRIC VIEW

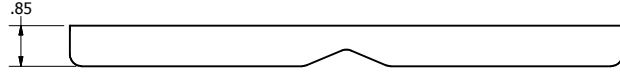
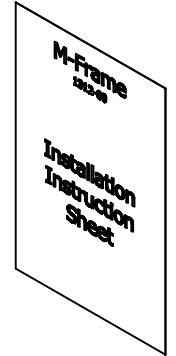
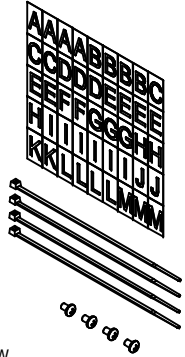

- NOTES:**
- Material: .090" Aluminum
  - Finish: Brushed
  - Mounting Holes to Match Most Manufacturers Mounting Plates
- Includes:**
- M-Frame Base
  - Mounting Screws
  - Cable Ties
  - Letter/Number Set
  - Installation Instructions

Oberon, Inc. - 1315 S. Allen St. - State College, PA 16801

|         |              |          |  |
|---------|--------------|----------|--|
| TITLE   |              |          |  |
| M-Frame |              |          |  |
| SIZE    | DWG NO       | DATE     |  |
| C       | 1312-XXX-XXX | 2/1/2019 |  |
| SCALE   | SHEET 1 OF 7 |          |  |

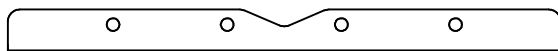
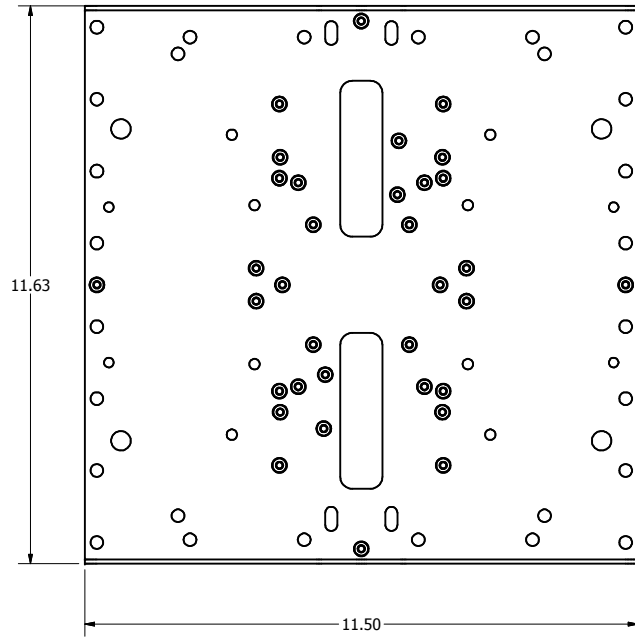

# 39-1312-AM1 - Omnidirectional Antenna Mounting Kit

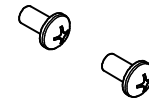
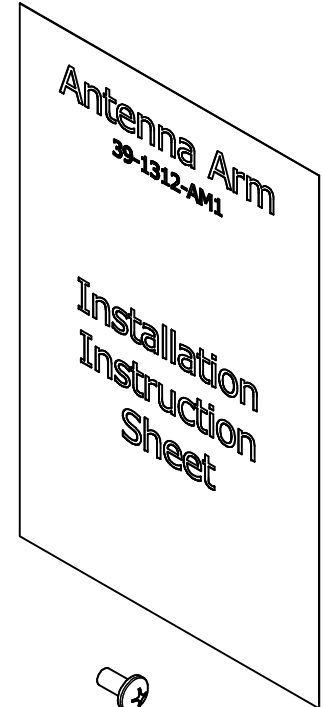
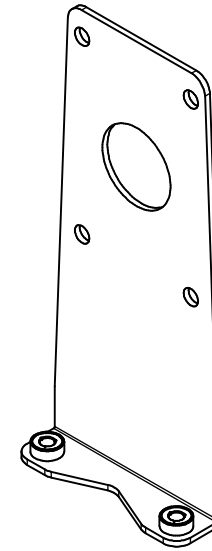
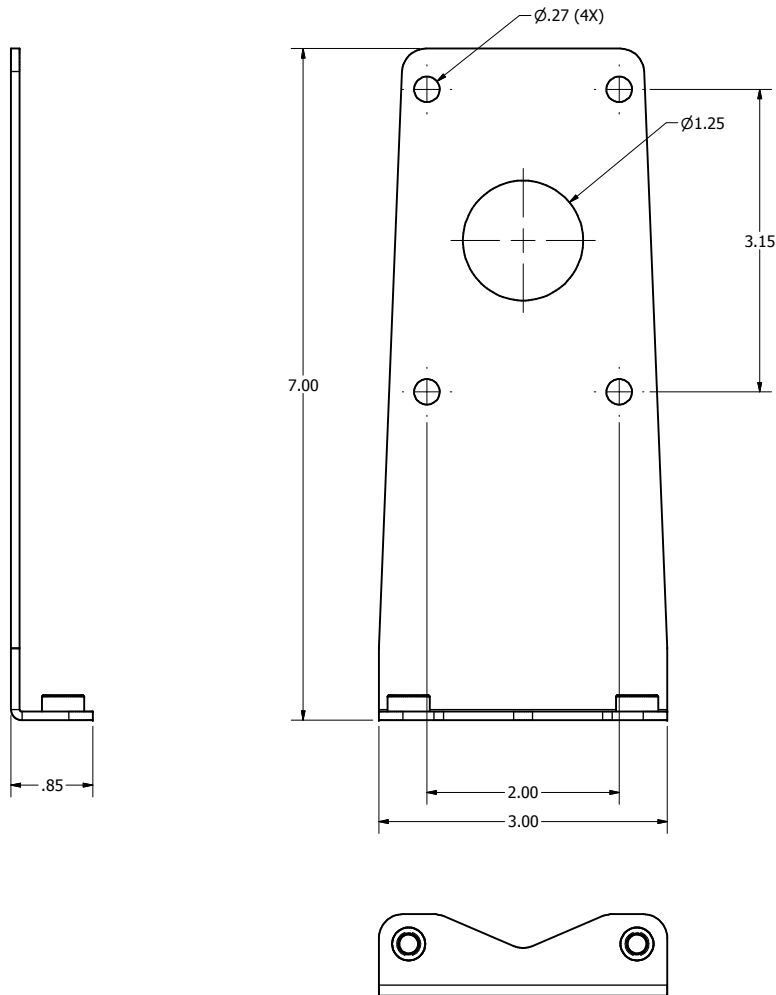

- NOTES:**
- Material: .090" Aluminum
  - Finish: Brushed
- Includes:**
- Mounting Bracket
  - Mounting Screws
  - Installation Instructions

|  |                        |                  |  |
|--|------------------------|------------------|--|
| Oberon, Inc. - 1315 S. Allen St. - State College, PA 16801 |                        |                  |  |
| TITLE<br>M-Frame   |                        |                  |  |
| SIZE<br>C  | DWG NO<br>1312-XXX-XXX | DATE<br>2/1/2019 |  |
| SCALE  | SHEET 2 OF 7           |                  |  |

# 39-1312-AM2 - Omnidirectional Pipe Antenna Mounting Kit

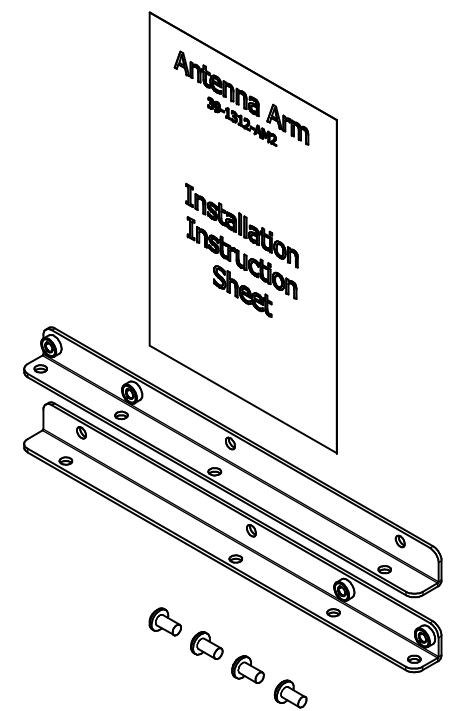
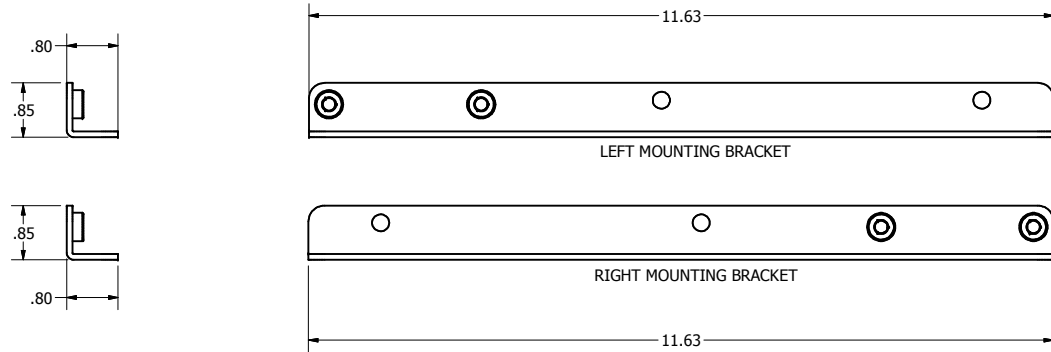

- NOTES:**
- Material: .090" Aluminum
  - Finish: Brushed
- Includes:**
- Left & Right Mounting Brackets
  - Mounting Screws
  - Installation Instructions

|  |                        |                  |  |
|--|------------------------|------------------|--|
| Oberon, Inc. - 1315 S. Allen St. - State College, PA 16801 |                        |                  |  |
| TITLE<br>M-Frame   |                        |                  |  |
| SIZE<br>C  | DWG NO<br>1312-XXX-XXX | DATE<br>2/1/2019 |  |
| SCALE  | SHEET 3 OF 7           |                  |  |

# 39-1312-AM3 - Patch Antenna Mounting Kit

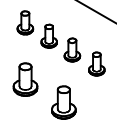
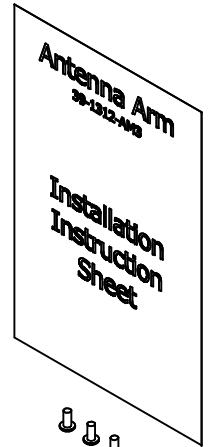
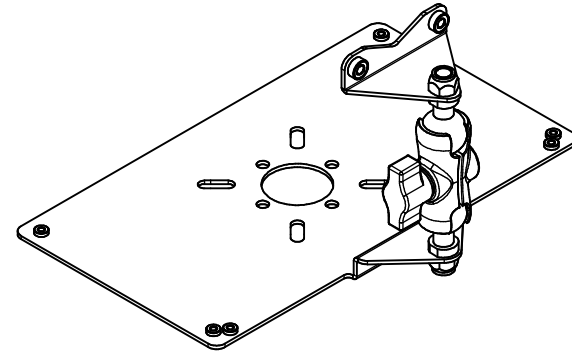
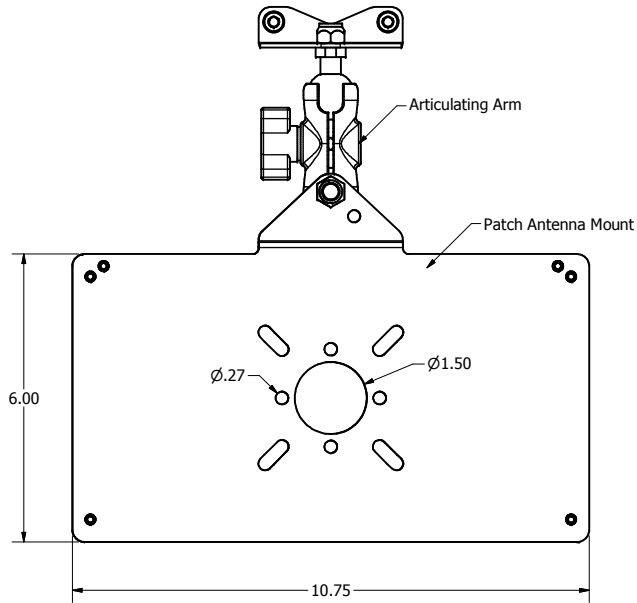
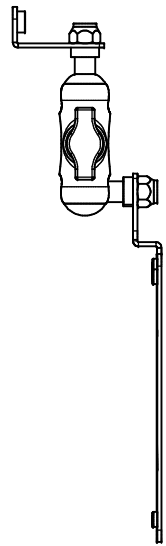

- NOTES:**
- Material: .090" Aluminum
  - Finish: Brushed
- Includes:**
- Mounting Bracket w/Articulating Arm
  - Mounting Screws
  - Installation Instructions

|  |              |          |  |
|--|--------------|----------|--|
| Oberon, Inc. - 1315 S. Allen St. - State College, PA 16801 |              |          |  |
| TITLE  |              |          |  |
| M-Frame  |              |          |  |
| SIZE   | DWG NO       | DATE     |  |
| C  | 1312-XXX-XXX | 2/1/2019 |  |
| SCALE  | SHEET 4 OF 7 |          |  |

# 39-1312-RAB - Right Angle Mounting Bracket Kit

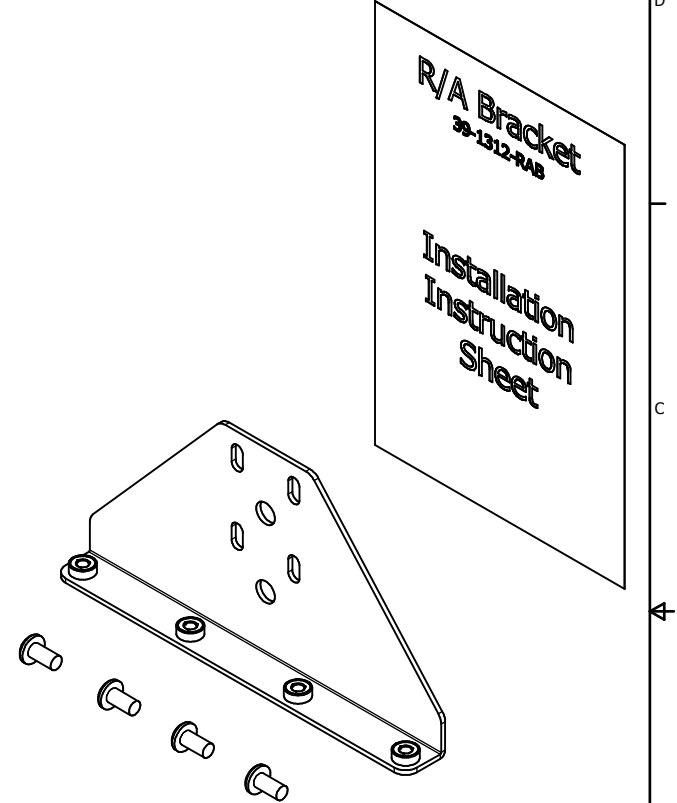
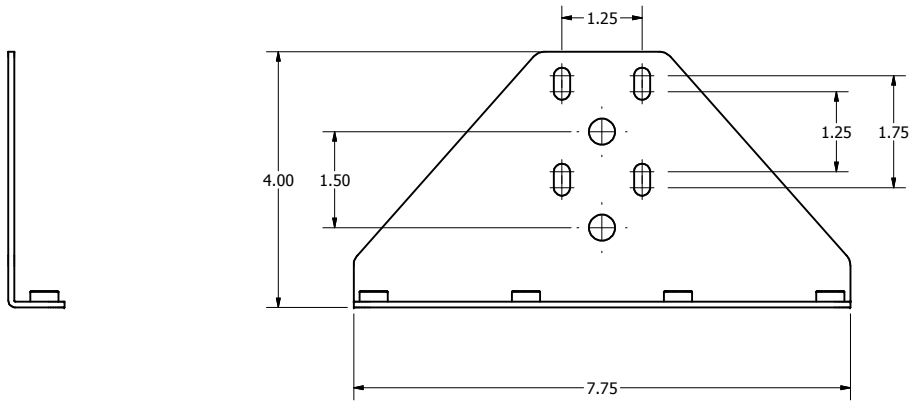

- NOTES:**
- Material: .090" Aluminum
  - Finish: Brushed
- Includes:**
- Right Angle Mounting Bracket
  - Mounting Screws
  - Installation Instructions

|  |              |          |  |
|--|--------------|----------|--|
| Oberon, Inc. - 1315 S. Allen St. - State College, PA 16801 |              |          |  |
| TITLE  |              |          |  |
| M-Frame  |              |          |  |
| SIZE   | DWG NO       | DATE     |  |
| C  | 1312-XXX-XXX | 2/1/2019 |  |
| SCALE  | SHEET 5 OF 7 |          |  |

**Hardware Kits**

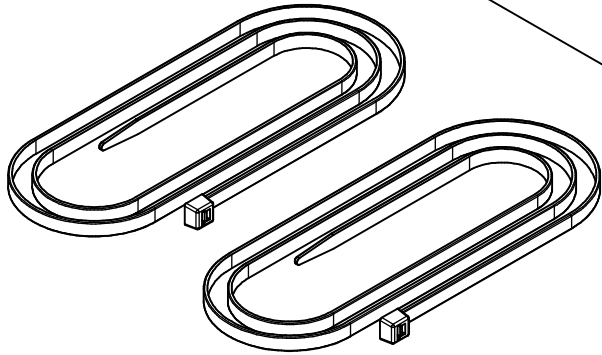
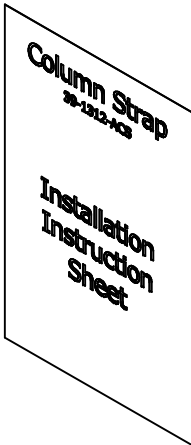

**39-1312-ACS - Adjustable Column Strap Kit**

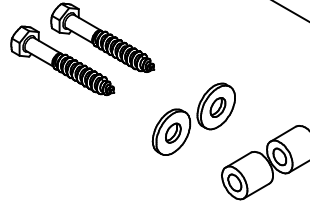
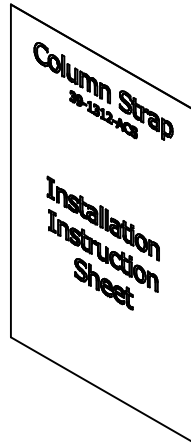

**39-1312-CWS - Cement Wall Anchor Kit**

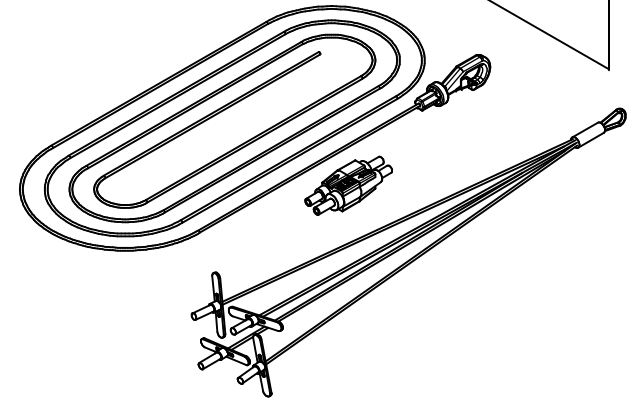
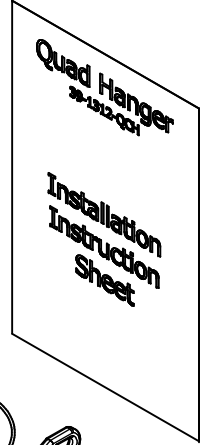

**39-1312-QCH - Quad Cable Hanger Kit**

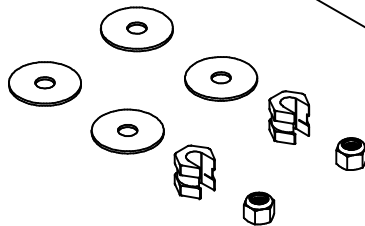
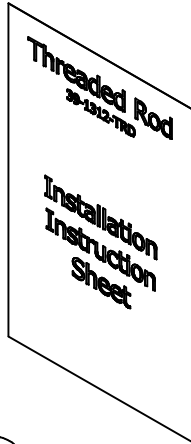

**39-1312-TRD - Threaded Rod Kit**

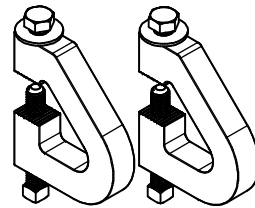
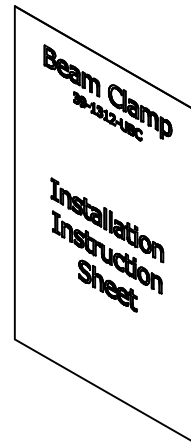

**39-1312-UBC - Universal Beam Clamp Kit**

|  |                        |                  |
|--|------------------------|------------------|
| Oberon, Inc. - 1315 S. Allen St. - State College, PA 16801 |                        |                  |
| TITLE<br>M-Frame   |                        |                  |
| SIZE<br>C  | DWG NO<br>1312-XXX-XXX | DATE<br>2/1/2019 |
| SCALE  | SHEET 6 OF 7           |                  |

# M-Frame Model Number Look-Up Table

\*NOTE - All model numbers include M-Frame base plus antenna mount / mounting option hardware kit specified below:

| M-FRAME LOOK-UP TABLE |                                       |   |
|-----------------------|---------------------------------------|---|
| MODEL NUMBER          | ANTENNA MOUNT                         | MOUNTING OPTION HARDWARE KIT              |
| 1312-00-ACS           | N/A                                   | 39-1312-ACS - Adjustable Column Strap Kit |
| 1312-00-CWA           | N/A                                   | 39-1312-CWS - Cement Wall Anchor Kit      |
| 1312-00-QCH           | N/A                                   | 39-1312-QCH - Quad Cable Hanger Kit       |
| 1312-00-TRD           | N/A                                   | 38-1312-TRD - Threaded Rod Kit            |
| 1312-00-UBC           | N/A                                   | 39-1312-UBC - Universal Beam Clamp Kit    |
| 1312-AM1-ACS          | 39-1312-AM1 - Antenna Mount           | 39-1312-ACS - Adjustable Column Strap Kit |
| 1312-AM1-CWA          | 39-1312-AM1 - Antenna Mount           | 39-1312-CWS - Cement Wall Anchor Kit      |
| 1312-AM1-QCH          | 39-1312-AM1 - Antenna Mount           | 39-1312-QCH - Quad Cable Hanger Kit       |
| 1312-AM1-TRD          | 39-1312-AM1 - Antenna Mount           | 38-1312-TRD - Threaded Rod Kit            |
| 1312-AM1-UBC          | 39-1312-AM1 - Antenna Mount           | 39-1312-UBC - Universal Beam Clamp Kit    |
| 1312-AM2-ACS          | 39-1312-AM2 - Antenna Mount           | 39-1312-ACS - Adjustable Column Strap Kit |
| 1312-AM2-CWA          | 39-1312-AM2 - Antenna Mount           | 39-1312-CWS - Cement Wall Anchor Kit      |
| 1312-AM2-QCH          | 39-1312-AM2 - Antenna Mount           | 39-1312-QCH - Quad Cable Hanger Kit       |
| 1312-AM2-TRD          | 39-1312-AM2 - Antenna Mount           | 38-1312-TRD - Threaded Rod Kit            |
| 1312-AM2-UBC          | 39-1312-AM2 - Antenna Mount           | 39-1312-UBC - Universal Beam Clamp Kit    |
| 1312-AM3-ACS          | 39-1312-AM3 - Antenna Mount           | 39-1312-ACS - Adjustable Column Strap Kit |
| 1312-AM3-CWA          | 39-1312-AM3 - Antenna Mount           | 39-1312-CWS - Cement Wall Anchor Kit      |
| 1312-AM3-QCH          | 39-1312-AM3 - Antenna Mount           | 39-1312-QCH - Quad Cable Hanger Kit       |
| 1312-AM3-TRD          | 39-1312-AM3 - Antenna Mount           | 38-1312-TRD - Threaded Rod Kit            |
| 1312-AM3-UBC          | 39-1312-AM3 - Antenna Mount           | 39-1312-UBC - Universal Beam Clamp Kit    |
|                       |                                       |   |
| MODEL NUMBER          | MOUNTING OPTION                       | MOUNTING OPTION HARDWARE KIT              |
| 1312-RAB-ACS          | 39-1312-RAB - Right Angle Bracket Kit | 39-1312-ACS - Adjustable Column Strap Kit |
| 1312-RAB-CWA          | 39-1312-RAB - Right Angle Bracket Kit | 39-1312-CWS - Cement Wall Anchor Kit      |
| 1312-RAB-UBC          | 39-1312-RAB - Right Angle Bracket Kit | 39-1312-UBC - Universal Beam Clamp Kit    |

|  |              |          |
|--|--------------|----------|
| Oberon, Inc. - 1315 S. Allen St. - State College, PA 16801 |              |          |
| TITLE  |              |          |
| M-Frame  |              |          |
| SIZE   | DWG NO       | DATE     |
| C  | 1312-XXX-XXX | 2/1/2019 |
| SCALE  | SHEET 7 OF 7 |          |