

User Manual for Lead Acid Line-Interactive UPS

VL-SeriesA

120VAC

800VA, 1100VA, 1500VA, 2000VA,
2200VA and 3000VA Models

VL-SeriesB

200-240VAC

3000VA and 5000VA Models

Reference Sales Model: VLxxxx

Version 1

April 2022



**CHATSWORTH
PRODUCTS**

800-834-4969

chatsworth.com

techsupport@chatsworth.com

While every effort has been made to ensure the accuracy of all information, CPI does not accept liability for any errors or omissions and reserves the right to change information and descriptions of listed services and products.

©2022 Chatsworth Products, Inc. All rights reserved. Chatsworth Products, Click-Nut, CPI, CPI Passive Cooling, eConnect, Evolution, GlobalFrame, MegaFrame, Motive, QuadraRack, RMR, Saf-T-Grip, Secure Array, SeismicFrame, SlimFrame, TeraFrame and Velocity are federally registered trademarks of Chatsworth Products. CUBE-iT, EuroFrame, Simply Efficient and ZetaFrame are trademarks of Chatsworth Products. All other trademarks belong to their respective companies. 04/22 MKT-60020-763

Table of Contents

Important Safety Warning

Transportation.....	4
Preparation.....	4
Installation.....	4
Operation.....	4
Maintenance, Service, and Faults	5

Installation and Setup

Rear Panel View.....	6
Operating Principle.....	8
Install the UPS.....	8
Setup the UPS.....	11
Battery Replacement.....	13
Battery Kit Assembly.....	16

Operations

Button Operation.....	20
LCD Panel.....	21
Audible Alarms.....	22
Abbreviations in LCD Display.....	23
UPS Setting.....	23
Operating Mode Description.....	27
Fault Reference Codes.....	28
Warning Indicators.....	28

Troubleshooting.....

Storage & Maintenance.....

Operation.....	30
Storage.....	30

Specifications.....

Obtaining Service.....

Limited Warranty.....

Appendix A: VXPB1& VXPB2 User Guide.....

Important Safety Instructions.....	35
Product Overview and Setup.....	35
Type of Battery Required.....	37
Battery Replacement.....	37
Wiring Diagram.....	42
Storage & Maintenance.....	44

Introduction

User Manual for Lead Acid Line Interactive UPS

VL-Series A: This document is the User Manual for CPI 120VAC, 800VA - 3000VA Lead Acid Pure Sine Wave Line Interactive Uninterruptible Power Supplies (UPS) (Sales Models VL800A, VL1100A, VL1500A, VL2000A, VL2200A, VL3000A, VL3000A-1).

VL-Series B: User Manual for CPI 200-240VAC, 3000VA - 5000VA Lead Acid Pure Sine Wave Line Interactive Uninterruptible Power Supplies (UPS) (Sales Models VL3000B, VL5000B, VL5000B-1).

©2022 Chatsworth Products, Inc. All rights reserved.
UL Listed for use in U.S. and Canada.

Legal Information

The information contained in this guide is subject to change without notice. Chatsworth Products, Inc. (CPI) shall not be liable for technical or editorial errors or omissions contained herein; nor is it liable for any injury, loss, or incidental or consequential damages resulting from the furnishing, performance or use of this material and equipment.

Important Safety Warning

Please comply with all warnings and operating instructions in this manual strictly. Save this manual properly and read carefully the following instructions before installing the unit. Do not operate this unit before reading through all safety information and operating instructions carefully.

Transportation

- Please transport the UPS system only in the original package to protect against shock and impact.

Preparation

- Condensation may occur if the UPS system is moved directly from cold to warm environment. The UPS system must be absolutely dry before being installed. Please allow at least two hours for the UPS system to acclimate the environment.
- Do not install the UPS system near water or in moist environments.
- Do not install the UPS system where it would be exposed to direct sunlight or near heater.
- Do not block ventilation holes in the UPS housing.

Installation

- Do not connect appliances or devices which would overload the UPS system (e.g. laser printers) to the UPS output sockets.
- Place cables in such a way that no one can step on or trip over them.
- Do not connect domestic appliances such as hair dryers to UPS output sockets.
- The UPS can be operated by any individuals with no previous experience.
- Connect the UPS system only to an earthed shockproof outlet which must be easily accessible and close to the UPS system.
- Please use power cables approved by regulatory agencies (e.g. the mains cable of your computer) to connect the UPS system to the building wiring outlet (shockproof outlet).
- Please use power cables approved by regulatory agencies to connect the loads to the UPS system.
- When installing the equipment, it should ensure that the sum of the leakage current of the UPS and the connected devices does not exceed 3.5mA.
- Temperature Rating - Units are considered acceptable for use in a maximum ambient of 40°C (104°F).
- For PLUGGABLE EQUIPMENT, the socket-outlet shall be installed near the equipment and shall be easily accessible.
- CAUTION: The unit is heavy. Lifting the unit requires a minimum of two people.
- Check if there is a protection device against over current and short circuit in the upstream of the UPS system. The recommended protection spec is 11A for 800VA, 1100VA, 15A for 1500VA, 20A for 2000VA, 2200VA and 30A for 3000VA with a B or C trip curve.

Operation

- Do not disconnect the mains cable on the UPS system or the building wiring outlet (shockproof socket outlet) during operations since this would cancel the protective earthing of the UPS system and of all connected loads.
- The UPS system features its own, internal current source (batteries). The UPS output sockets or output terminals block may be electrically live even if the UPS system is not connected to the building wiring outlet.

- In order to fully disconnect the UPS system, first press the OFF/Enter button to disconnect the mains.
- Prevent no fluids or other foreign objects from inside of the UPS system.
- The EPO, RS-232 and USB circuits are an IEC 60950 safety extra low voltage (SELV) circuit. This circuit must be separated from any hazardous voltage circuits by reinforced insulation.

Maintenance, Service, and Faults

- The UPS system operates with hazardous voltages. Repairs may be carried out only by qualified maintenance personnel.
- **Caution** - risk of electric shock. Even after the unit is disconnected from the mains (building wiring outlet), components inside the UPS system are still connected to the battery and electrically live and dangerous.
- Before carrying out any kind of service and/or maintenance, disconnect the batteries and verify that no current is present and no hazardous voltage exists in the terminals of high capability capacitor such as BUS-capacitors.
- To avoid electrical shock, turn off the unit and unplug it from the AC power source before servicing the battery.
- Only persons are adequately familiar with batteries and with the required precautionary measures may replace batteries and supervise operations. Unauthorized persons must be kept well away from the batteries.
- **Caution** - risk of electric shock. The battery circuit is not isolated from the input voltage.
- Hazardous voltages may occur between the battery terminals and the ground. Before touching, please verify that no voltage is present!
- Batteries may cause electric shock and have a high short-circuit current. Please take the precautionary measures specified below and any other measures necessary when working with batteries:
 - » Remove wristwatches, rings and other metal objects
 - » Use only tools with insulated grips and handles.
- When changing batteries, install the same number and same type of batteries.
- Do not attempt to dispose of batteries by burning them. This could cause battery explosion.
- Do not open or destroy batteries. Escaping electrolyte can cause injury to the skin and eyes. It may be toxic.
- When replacing batteries, replace with the same type and number of batteries or battery packs.
- Do not dismantle the UPS system.
- A battery can present a risk of electrical shock and high short-circuit current. The following precautions should be observed when working on batteries:
 - » Remove watches, rings, or other metal objects.
 - » Use tools with insulated handles.
 - » Wear rubber gloves and boots.
 - » Do not lay tools or metal parts on top of batteries.
 - » Disconnect charging source prior to connecting or disconnecting battery terminals.
 - » Determine if battery is inadvertently grounded. If inadvertently grounded, remove source from ground. Contact with any part of a grounded battery can result in electrical shock. The likelihood of such shock can be reduced if such grounds are removed during installation and maintenance.

Installation and Setup

NOTE: Before installation, please inspect the unit. Be sure that nothing inside the package is damaged. Please keep the original package in a safe place for future use.

Rear Panel View

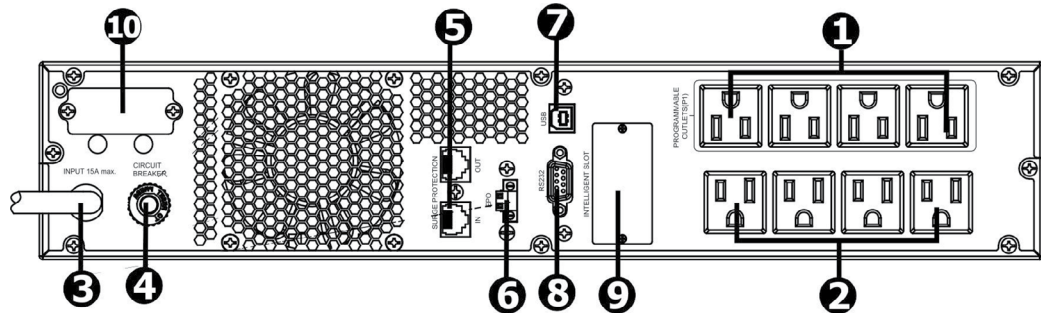

VL800A, VL1100A, VL1500A, Rear View

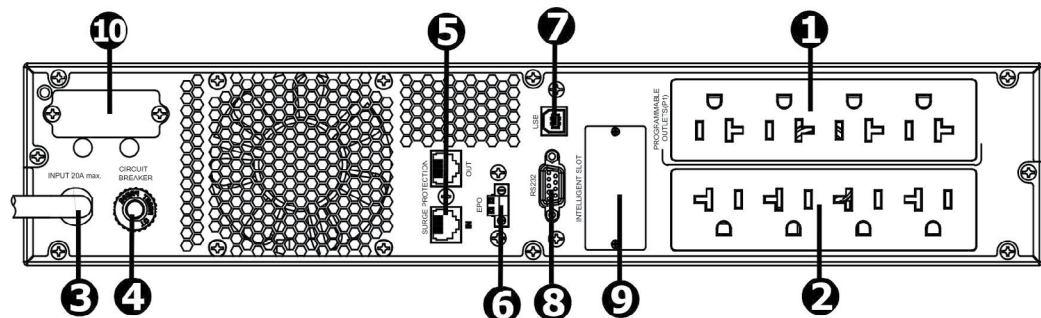

VL2000A, VL2200A, VL3000A

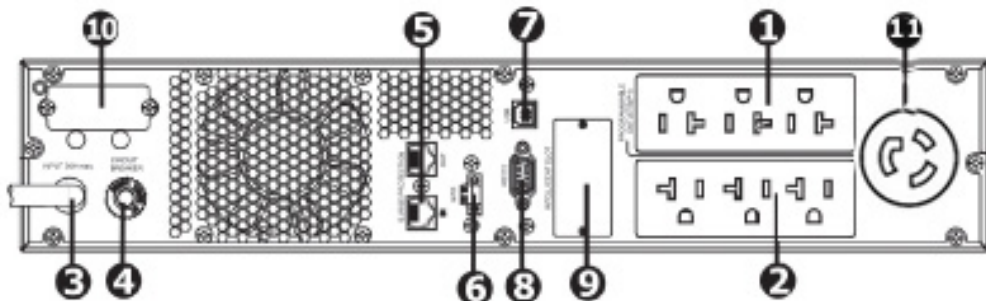

VL3000A-1

1. Programmable outlets: connect to non-critical loads.
2. Output receptacles: connect to mission-critical loads.
3. AC input
4. Input circuit breaker
5. Network/Fax/Modem surge protection
6. Emergency power off function connector (EPO)
7. USB communication port
8. RS-232 communication port
9. SNMP intelligent slot
10. External battery connector

NOTE: Before installation, please inspect the unit. Be sure that nothing inside the package is damaged. Please keep the original package in a safe place for future use.

Rear Panel View

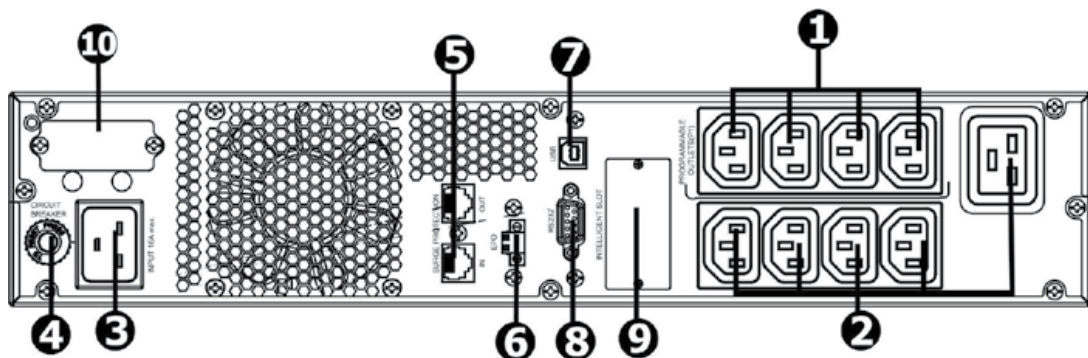

VL3000B, Rear View

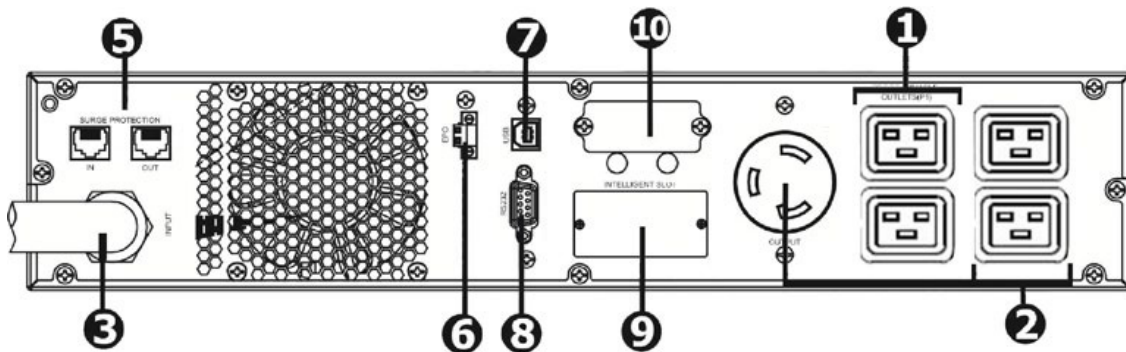

VL5000B, Rear View

1. Programmable outlets: connect to non-critical loads.
2. Output receptacles: connect to mission-critical loads.
3. AC input
4. Input circuit breaker
5. Network/Fax/Modem surge protection
6. Emergency power off function connector (EPO)
7. USB communication port
8. RS-232 communication port
9. SNMP intelligent slot
10. External battery connector

Operating Principle

The operating principle of the UPS is shown below.

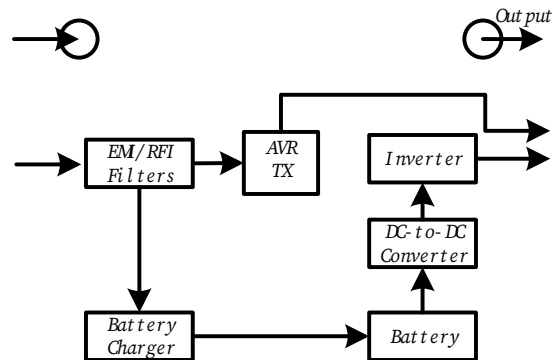

The UPS is composed of mains input, EMI/RFI Filters, Inverter, Battery charger, DC-to-DC converter, battery, AVR TX and UPS output.

Install the UPS

For safety consideration, the UPS is shipped out from factory without connecting battery wires. Before installing the UPS, please follow below steps to re-connect battery wires first.

Step 1: Remove front panel.

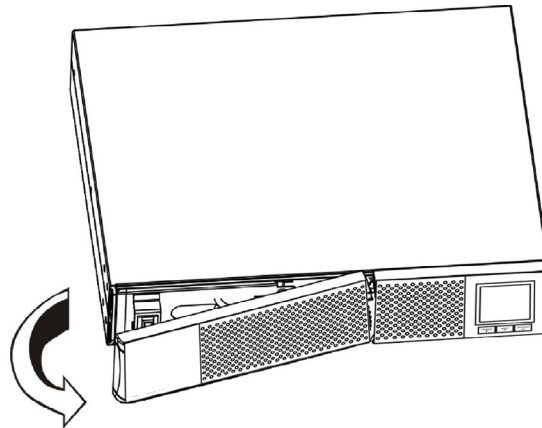

Step 2: Connect the AC input and re-connect battery wires.

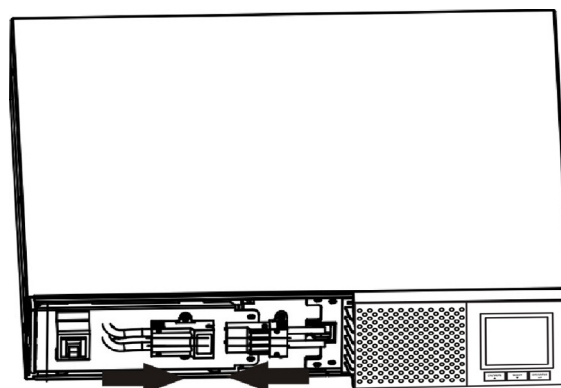

Step 3: Put the front panel back to the unit.

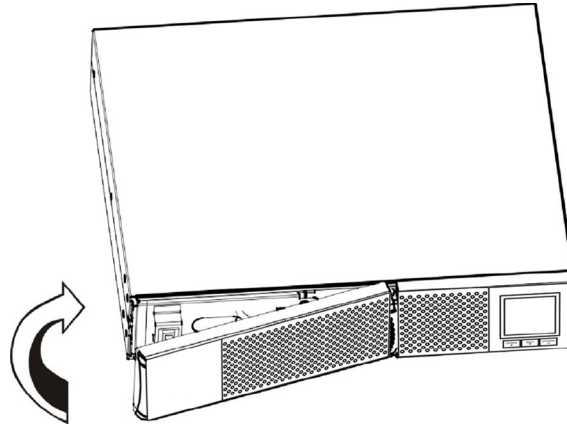

Rack-mount Installation

CAUTION – Do NOT use the mounting brackets to lift the unit. The mounting brackets are only for securing the unit to the rack.

Step 1

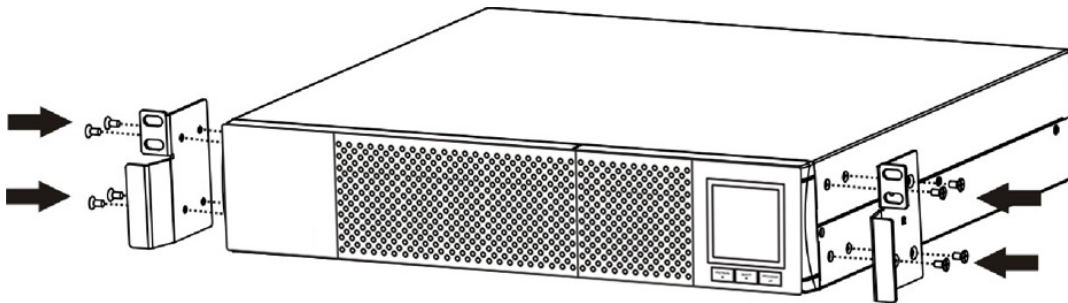

Step 2

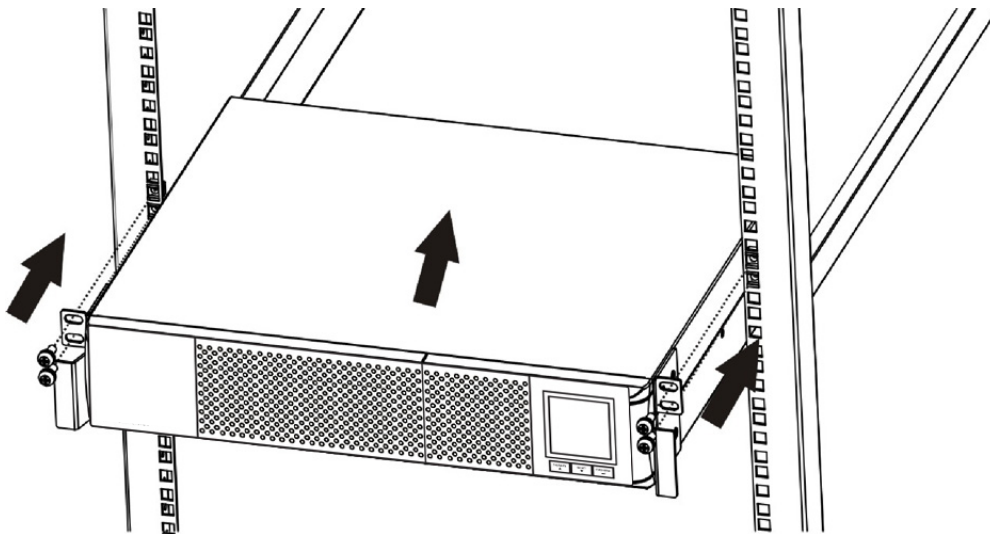

Tower Installation

Step 1

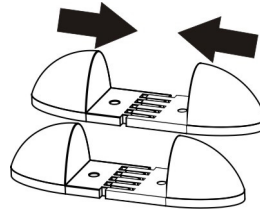

Step 2

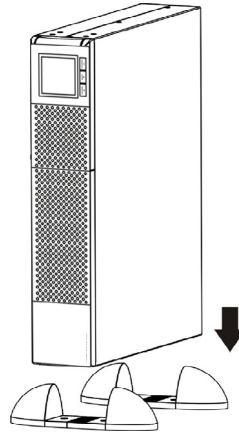

Step 3

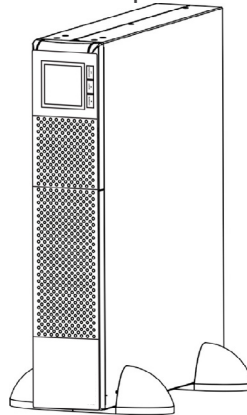

NOTE: When installing the UPS or battery pack with feet, please keep 2.75 in (70 mm) distance from the edge of the unit.

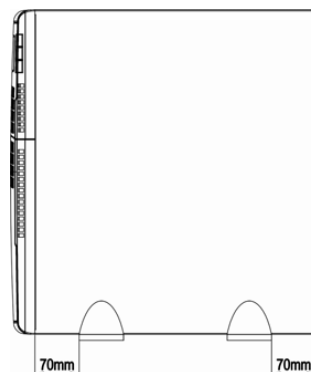

Setup the UPS

UPS input connection

Plug the UPS into a two-pole, three-wire, grounded receptacle only. Avoid using extension cords.

UPS output connection

There are two kinds of outputs: programmable outlets and general outlets. Please connect non-critical devices to the programmable outlets and critical devices to the general outlets. During power failure, you may extend the backup time to critical devices by setting shorter backup time for non-critical devices.

Communication connection

Communication ports:

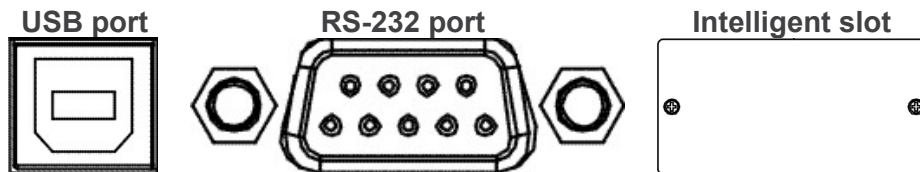

To allow for unattended UPS shutdown/start-up and status monitoring, connect the communication cable one end to the USB/RS-232 port and the other to the communication port of your PC. With the monitoring software installed, you can schedule UPS shutdown/start-up and monitor UPS status through PC.

The UPS is equipped with intelligent slot perfect for either SNMP or Dry Contact/Relay card. When installing either SNMP or Dry Contact/Relay card in the UPS, it will provide advanced communication and monitoring options.

USB port and RS-232 port can't work at the same time.

Surge Protection

Fax/Phone surge port

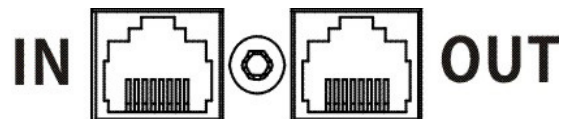

Connect a single modem/phone/fax line into surge-protected "IN" outlet on the back panel of the UPS unit. Connect from "OUT" outlet to the equipment with another modem/fax/phone line cable.

Disable and enable EPO function

Keep the pin 1 and pin 2 closed for UPS normal operation. To activate EPO function, cut the wire between pin 1 and pin 2.

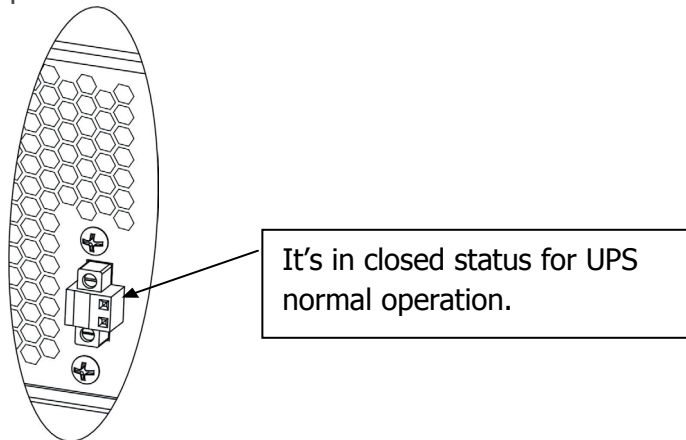

External battery connection

Connect one end of external battery cable to UPS unit and the other end to battery box. Use supplied battery detection wire in detection port of UPS unit and plug the other end to battery bank.

CAUTION: Connection to External Battery shall be installed by SERVICE PERSONNEL only.

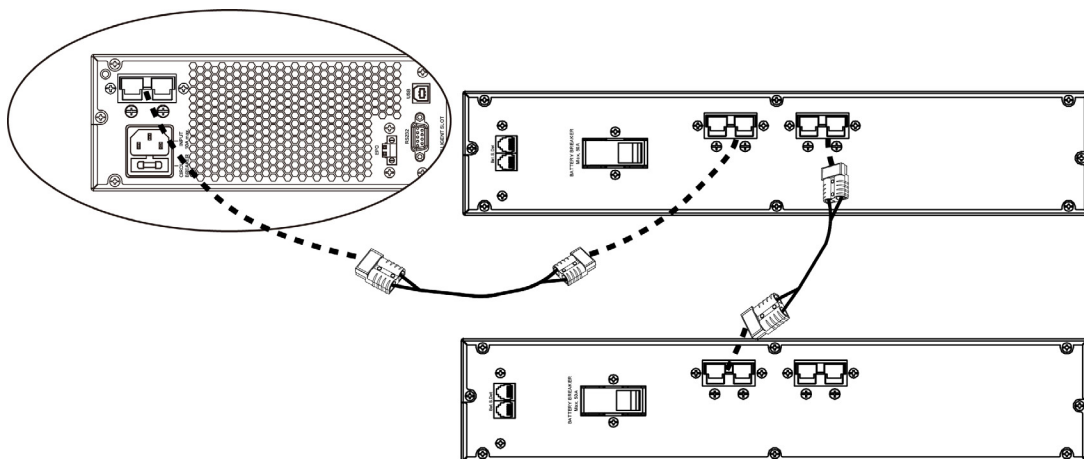

NOTE: It's only allowed to connect external battery boxes up to 1 units.

Turn on the UPS

Press the ON/Mute button on the front panel for two seconds to power on the UPS.

Note: The battery charges fully during the first five hours of normal operation. Do not expect full battery run capability during this initial charge period.

Install software

For optimal computer system protection, install UPS monitoring software to fully configure UPS shutdown. Please follow steps below to download and install monitoring software:

1. Go to the website <https://www.chatsworth.com/software>
2. Under Uninterruptible Power Supplies, click ViewPower software icon and then choose your required OS to download the software.
3. Follow the on-screen instructions to install the software.
4. When your computer restarts, the monitoring software will appear as an orange plug icon located in the system tray, near the clock.

Battery Replacement

NOTICE: This UPS is equipped with internal batteries and only service person can replace the batteries.

CAUTION! Consider all warnings, cautions, and notes before replacing batteries.

Note: Upon battery disconnection, equipment is not protected from power outages.

Step 1: Remove front panel.

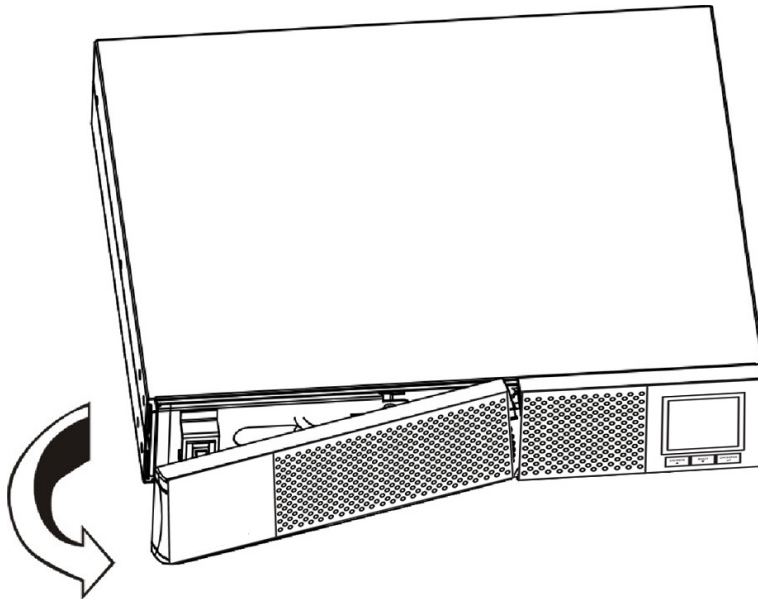

Step 2: Disconnect battery wires.

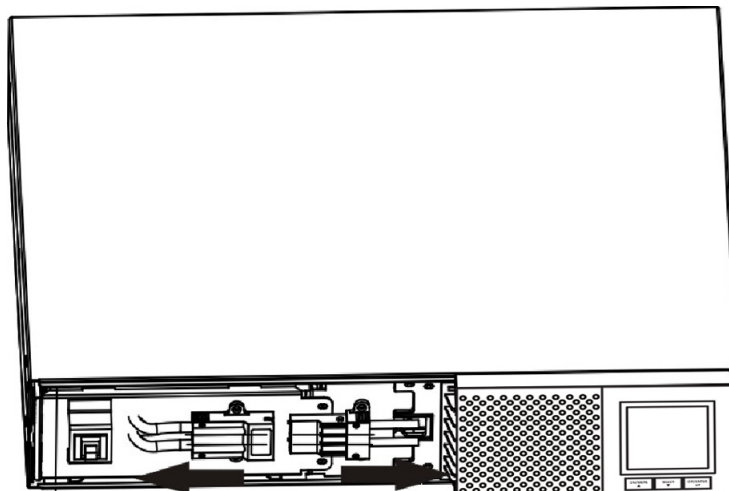

Step 3: Pull out the battery box by removing two screws on the front panel.

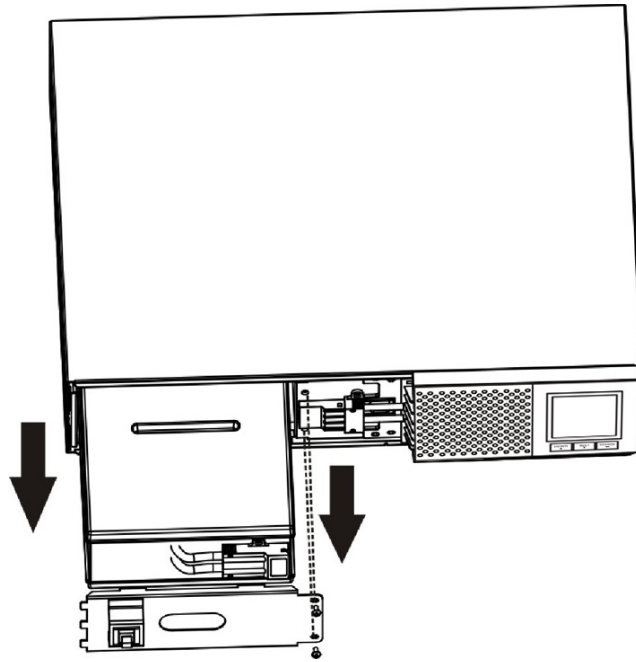

Step 4: Remove the top cover of battery box and replace the inside batteries.

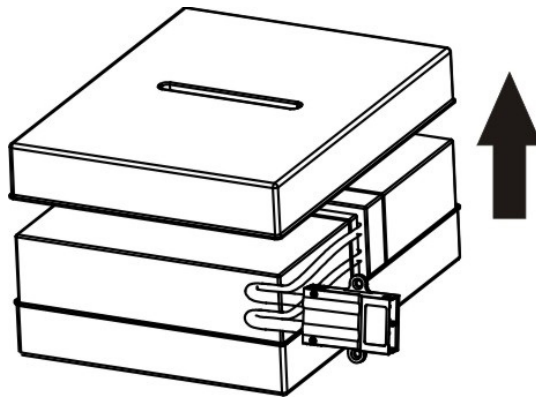

Step 5: After replacing the batteries, put the battery box back to original location and screw it tightly.

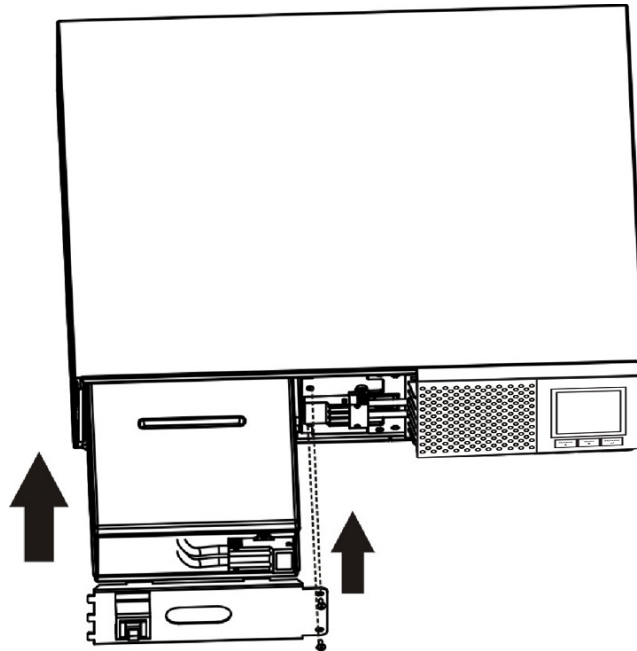

Step 6: Re-connect the battery wires.

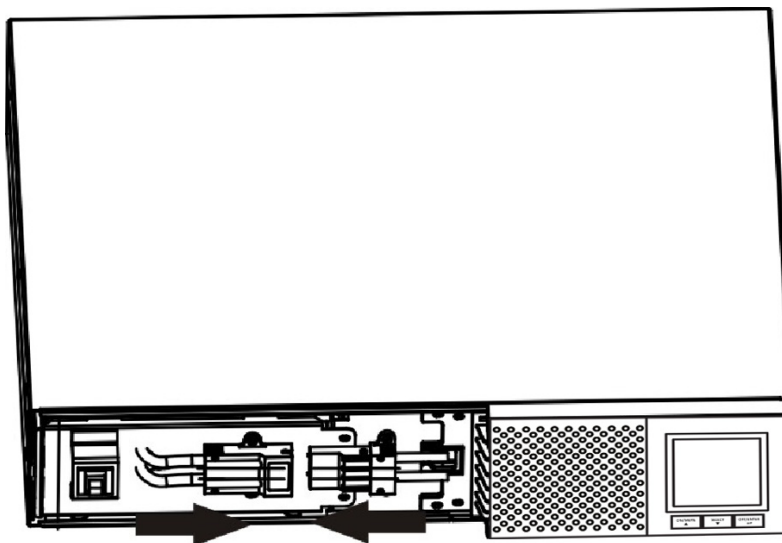

Step 7: Put the front panel back to the unit.

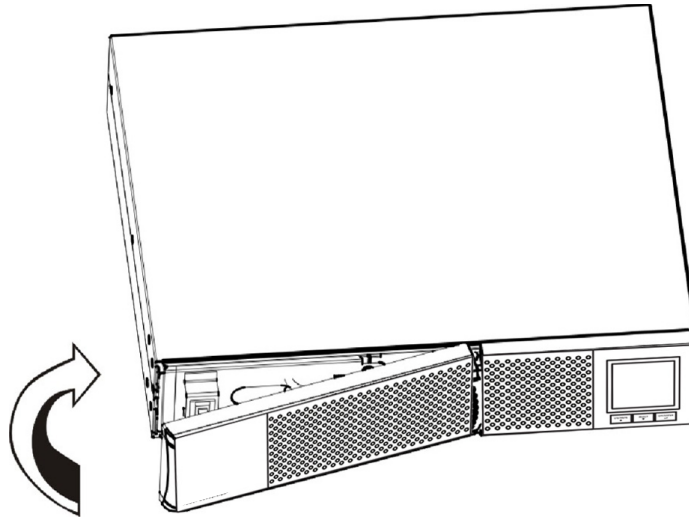

Battery Kit Assembly

NOTICE: Please assemble battery kit first before installing it inside of UPS. Please select correct battery kit procedure below to assemble it.

Two Battery Kit

Step 1: Remove adhesive tapes.

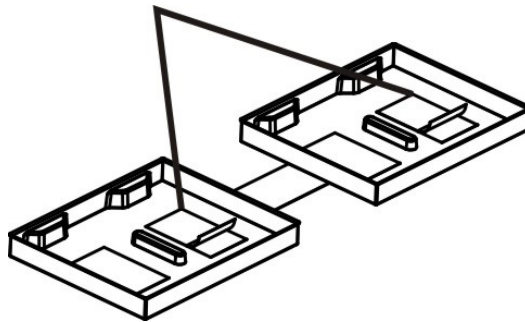

Step 2: Connect all battery terminals by following below diagram.

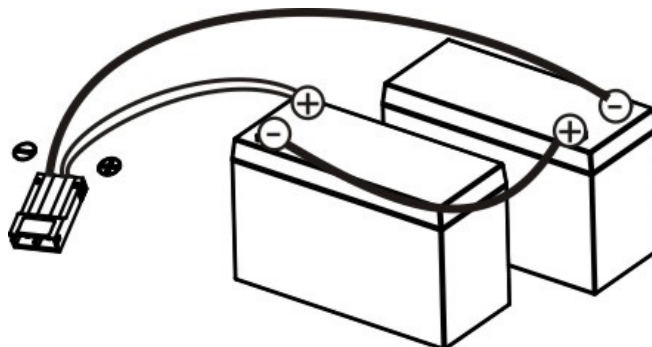

Step 3: Put assembled battery packs on one side of plastic shells and insert one more defect battery on the space.

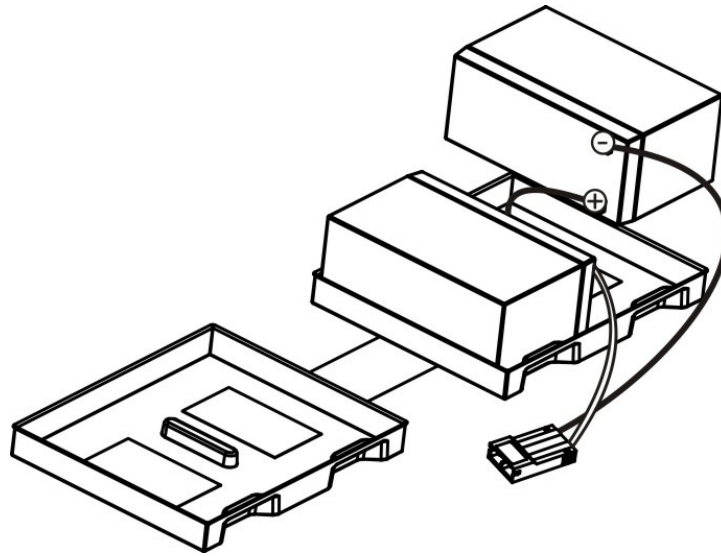

Step 4: Cover the other side of plastic shell as below chart. Then, battery kit is fully assembled.

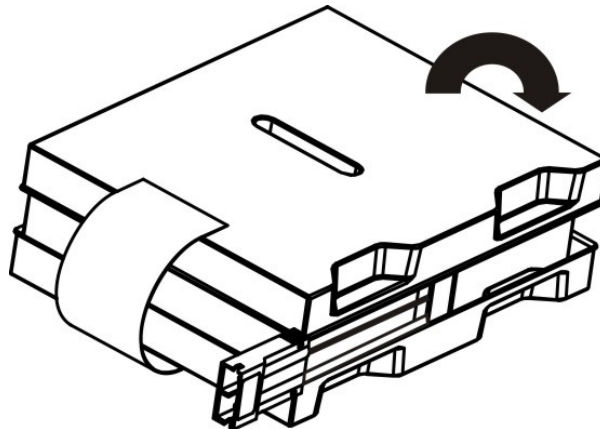

Four Battery Kit

Step 1: Remove adhesive tapes.

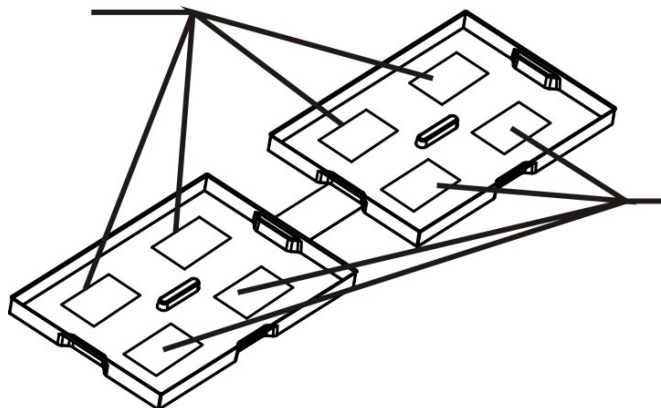

Step 2: Connect all battery terminals by following below diagram.

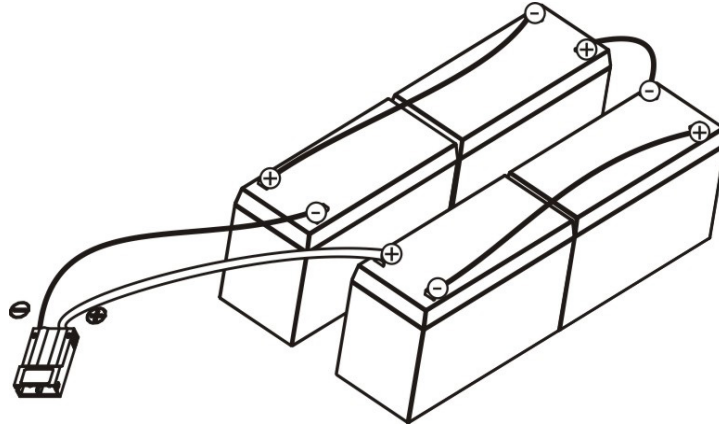

Step 3: Put assembled battery packs on one side of plastic shells.

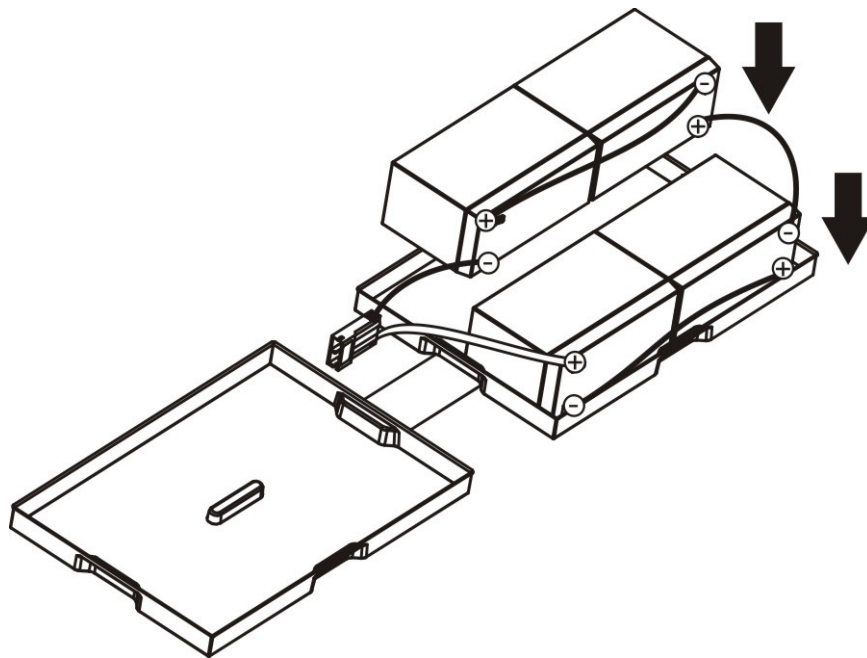

Step 4: Cover the other side of plastic shell as below chart. Then, battery kit is fully assembled.



Six Battery Kit

Step 1: Remove adhesive tapes.

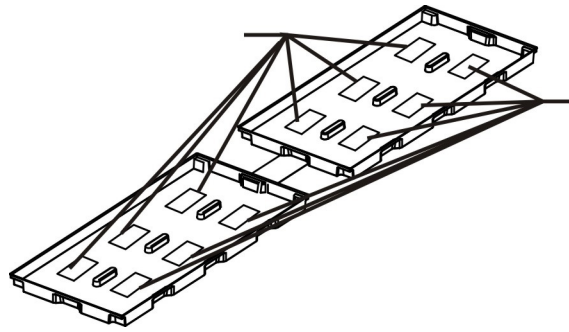

Step 2: Connect all battery terminals by following below diagram.

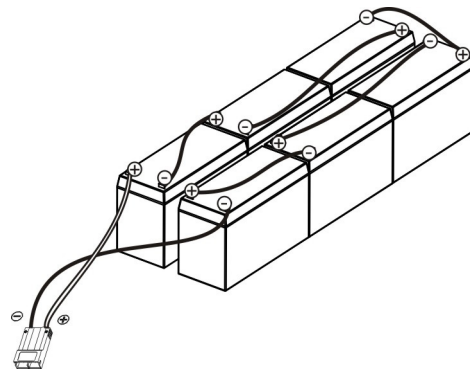

Step 3: Put assembled battery packs on one side of plastic shells.

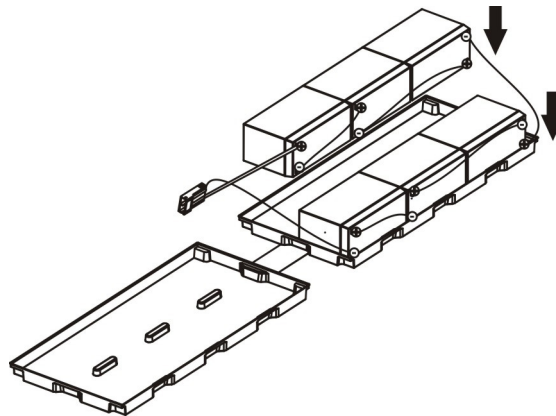

Step 4: Cover the other side of plastic shell as below chart. Then, battery kit is fully assembled.

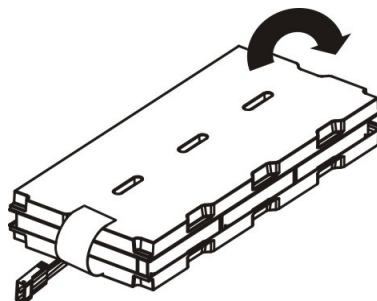

Operations

Button Operation



Button	Function
ON/MUTE Button	<ul style="list-style-type: none"> • Turn on the UPS: Press and hold ON/Mute button for at least 2 seconds to turn on the UPS. • Mute the alarm: After the UPS is turned on in battery mode, press and hold this button for at least 3 seconds to disable or enable the alarm system. But it's not applied to the situations when warnings or errors occur. • Up key: Press this button to display previous selection in UPS setting mode. • Switch to UPS self-test mode: Press and hold ON/Mute button for 3 seconds to enter UPS self-testing while in AC mode
OFF/ENTER Button	<ul style="list-style-type: none"> • Turn off the UPS: Press and hold this button at least 2 seconds to turn off the UPS • Confirm selection key: Press this button to confirm selection in UPS setting mode.
SELECT Button	<ul style="list-style-type: none"> • Switch LCD message: Press this button to change the LCD message for input voltage, input frequency, battery voltage, output voltage and output frequency. • Setting mode: Press and hold this button for 3 seconds to enter UPS setting mode when UPS is off. • Down key: Press this button to display next selection in UPS setting mode.
Select + OFF/Enter Button	<ul style="list-style-type: none"> • Rack or Tower display switch: Press Select and OFF/Enter buttons simultaneously for 3 seconds. The display changes from/to Rack to/from Tower.

LCD Panel



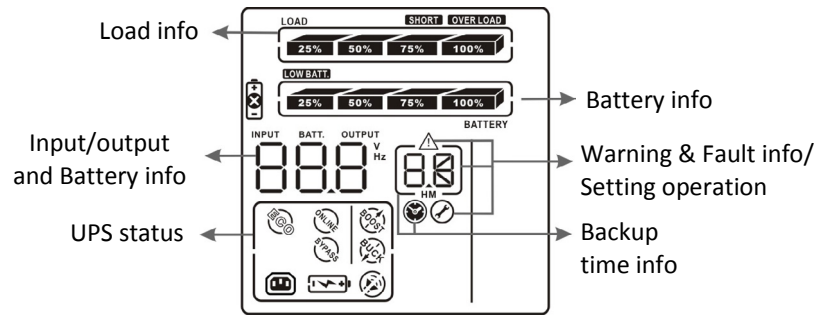



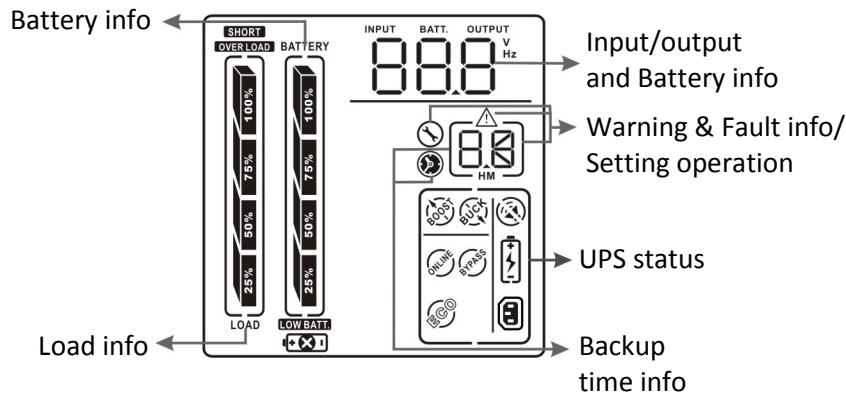

Rack Display



Tower Display



Display	Function
Backup Time Information	
	Indicates the backup time in pie chart.
	Indicates the backup time in numbers. H: hours, M: minutes
Warning & Fault Information	
	Indicates that the warning and fault occurs.
	Indicates the warning fault codes, which are listed in detail in this manual.
Setting Operation	
	Indicates the setting operation.
Input / Output & Battery Information	
	Indicates the output/input voltage, output/input frequency or battery voltage. V: output voltage, Hz: frequency

Load Information	
	Indicates the load level by 0-25%, 26-50%, 51-75%, and 76-100%.
OVER LOAD	Indicates overload.
SHORT	Indicates the load or the UPS output is short circuited.
UPS Status	
	Indicates that programmable management outlets are working.
	Indicates that the UPS alarm is disabled.
	Indicates the UPS powers the output directly from the mains
	Indicates the battery charger is working.
	Indicates the UPS is working in boost mode
	Indicates the UPS is working in buck mode
Battery Information	
	Indicates the Battery level by 0-25%, 26-50%, 51-75%, and 76-100%.
LOW BATT.	Indicates low battery.
	Indicates there is something wrong with the battery.

Audible Alarms

Description	Buzzer status
Battery Mode	Sounds every 10 seconds
Low Battery	Sounds every 2 seconds
Overload	Sounds every second
Fault	Continuously sounds

Abbreviations in LCD Display

Abbreviation	Display	Meaning
ENA	ENA	Enable
DIS	DIS	Disable
ESC	ESC	Escape
ON	ON	ON
OK	OK	OK
EP	EP	EPO
TP	TP	Temperature
CH	CH	Charger
RAC	RAC	Rack display
TOE	TOE	Tower display
SF	SF	Site Fault
EE	EE	EEPROM error
BR	BR	Battery Replacement

UPS Setting

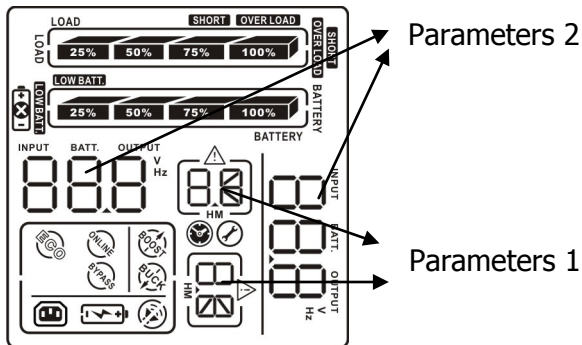

There are two parameters to set up the UPS.
 Parameter 1: For program alternatives
 Refer to below table for details.
 Parameter 2: For setting options or values for each program.

01: Output Voltage Settings (VL-XXXXA)

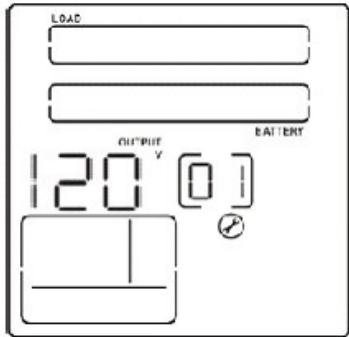
Interface	Setting
	<p>You may choose the following output voltage:</p> <ul style="list-style-type: none"> 110: presents output voltage as 110VAC 115: presents output voltage as 115VAC 120: presents output voltage as 120VAC (Default) 127: presents output voltage as 127VAC

01: Output Voltage Settings (VL-XXXXB)

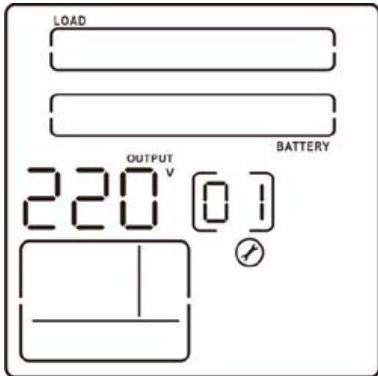
Interface	Setting
	<p>You may choose the following output voltage:</p> <ul style="list-style-type: none"> 208: presents output voltage is 208VAC 220: presents output voltage is 220VAC 230: presents output voltage is 230VAC (Default) 240: presents output voltage is 240VAC

02: Programmable Outlets Enable/Disable

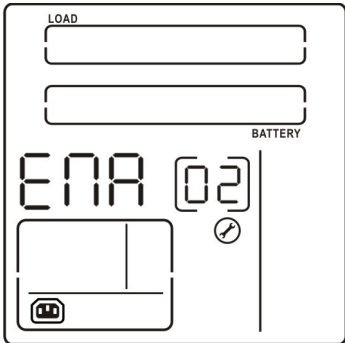
Interface	Setting
	<p>ENA: Programmable outlets enable (Default) DIS: Programmable outlets disable</p>

03: Programmable Outlets Setting

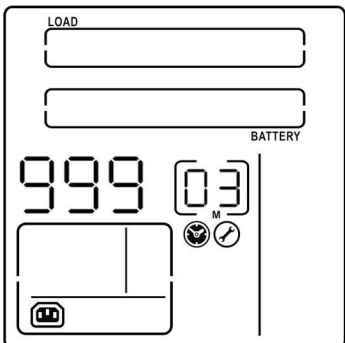
Interface	Setting
	<p>Setting the backup time limit in minutes from 0-999 for programmable outlets which connect to non-critical devices on battery mode.</p>

04: Maximum Charger Current Setting

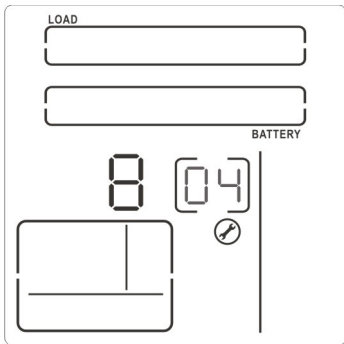
Interface	Setting
 <p>The LCD display shows two horizontal bars at the top labeled 'LOAD' and 'BATTERY'. Below them, the number '8' is displayed on the left and '04' on the right. A battery icon is visible on the right side of the display area.</p>	<p>Set up the maximum charger current. 1/2/4/6/8: Setting the maximum charger current at 1/2/4/6/8A (Default: 8A). Note: This setting is only effective for super charger.</p>

05: LCD Display Direction Setting

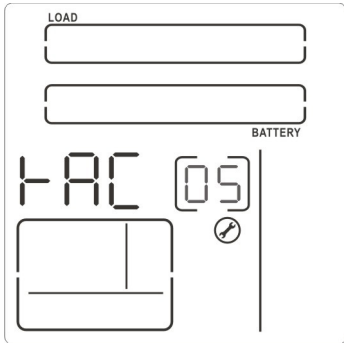
Interface	Setting
 <p>The LCD display shows two horizontal bars at the top labeled 'LOAD' and 'BATTERY'. Below them, the text 'RAC' is displayed on the left and '05' on the right. A battery icon is visible on the right side of the display area.</p>	<p>RAC: the LCD display is horizontal. TOE: the LCD display is vertical.</p>

06: Autonomy Limitation Setting

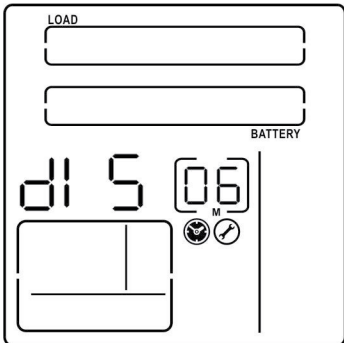
Interface	Setting
 <p>The LCD display shows two horizontal bars at the top labeled 'LOAD' and 'BATTERY'. Below them, the text 'di 5' is displayed on the left and '06' on the right. A battery icon and a small 'M' icon are visible on the right side of the display area.</p>	<p>Parameter 2: Set up backup time on battery mode for general outlets. 0-999: setting the backup time in minutes from 0-999 for general outlets on battery mode. DIS: Disable the autonomy limitation and the backup time will depend on battery capacity. (Default) Note: When setting is "0", the backup time will be only 10 seconds.</p>

07: Battery Total AH Setting

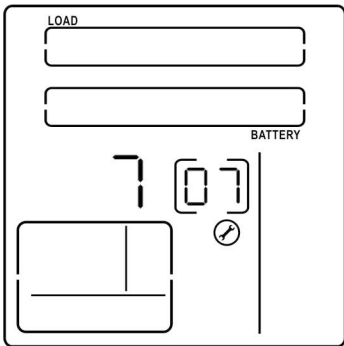
Interface	Setting
	<p>Parameter 2: Set up the battery total AH of the UPS. 7-999: setting the battery total capacity from 7-999 in AH. Please set the correct battery total capacity if external battery bank is connected.</p>

00: Exit setting

Steps for setting programmable outlet

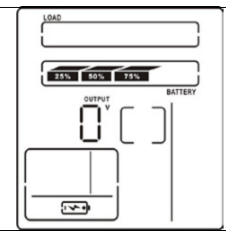
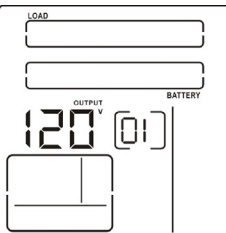
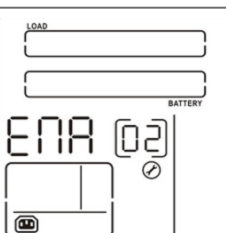
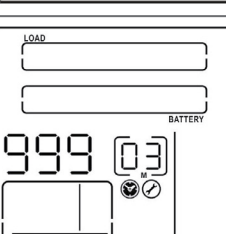
<p>Step 1: Before entering setting mode, the UPS should be in Stand-by mode (off-charging) and make sure the battery is connected. The LCD display is shown as right.</p>	
<p>Step 2: Press and hold the "Select" button for 3 seconds to enter Setting mode.</p>	
<p>Step 3: Press the "Up" button (ON/MUTE) to switch to "02" of program list. Then press "Enter" button to enter value setting of parameter 2. Press the "Up" button to change the value to "ENA" to enable the programmable outlet function. Then press "Enter" button again to confirm the setting.</p>	
<p>Step 4: Press the "Up" button (ON/MUTE) again to switch to "03" of program list. Then press "Enter" button for setting programmable outlet time. Push "Up" button to change the value of backup time desired. Then press "Enter" to confirm the setting.</p>	
<p>Step 5: Press "Up" button (ON/MUTE) to switch to "00" of program list. Then press "Enter" button to exit setting menu.</p>	
<p>Step 6: Disconnect AC input and wait until the LCD display is off. The new setting will be activated when turning on the UPS again.</p>	

Operating Mode Description

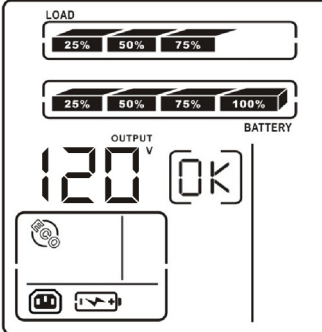
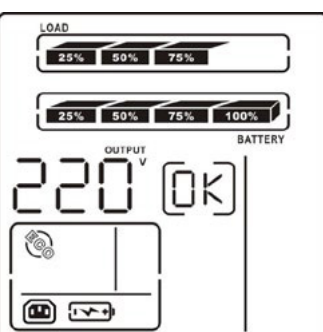
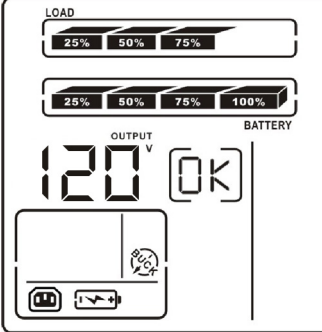
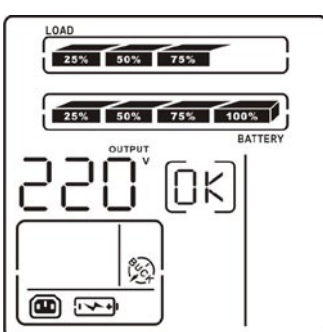
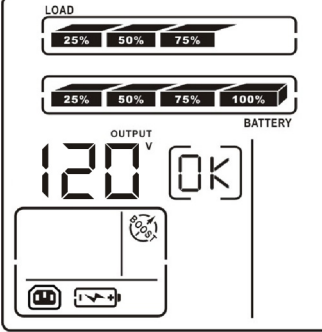
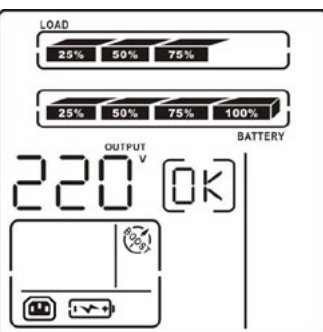
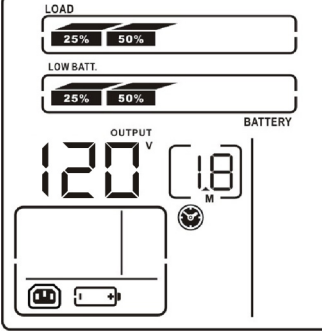
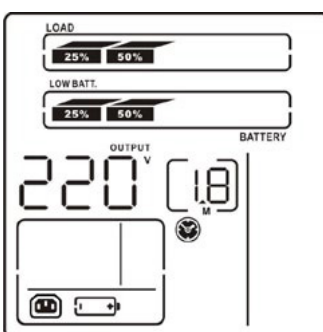

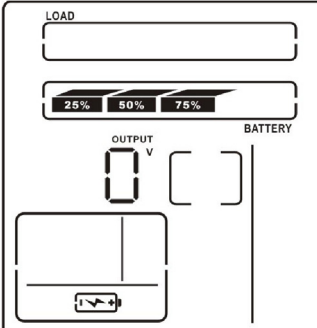
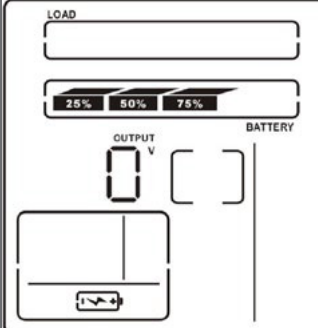





Operating Mode	Description	LCD Display (VL-XXXXA)	LCD Display (VL-XXXXB)
ECO mode	When the input voltage is within voltage regulated range, UPS will power the output directly from the mains. ECO is an abbreviation of Efficiency Corrective Optimizer. In this mode, when battery is fully charged, the fan will stop working for energy saving.	 <p>The display shows two load bars (top and bottom) with 25%, 50%, and 75% markers. The output voltage is 120V and the status is OK. A fan icon is present, and the battery level is shown as fully charged.</p>	 <p>The display shows two load bars (top and bottom) with 25%, 50%, 75%, and 100% markers. The output voltage is 220V and the status is OK. A fan icon is present, and the battery level is shown as fully charged.</p>
Buck mode when AC is normal.	When the input voltage is higher than the voltage regulation range but lower than high loss point, the buck AVR will be activated.	 <p>The display shows two load bars (top and bottom) with 25%, 50%, and 75% markers. The output voltage is 120V and the status is OK. A buck AVR icon is present, and the battery level is shown as fully charged.</p>	 <p>The display shows two load bars (top and bottom) with 25%, 50%, 75%, and 100% markers. The output voltage is 220V and the status is OK. A buck AVR icon is present, and the battery level is shown as fully charged.</p>
Boost mode when AC is normal.	When the input voltage is lower than the voltage regulation range but higher than low loss point, the boost AVR will be activated.	 <p>The display shows two load bars (top and bottom) with 25%, 50%, and 75% markers. The output voltage is 120V and the status is OK. A boost AVR icon is present, and the battery level is shown as fully charged.</p>	 <p>The display shows two load bars (top and bottom) with 25%, 50%, 75%, and 100% markers. The output voltage is 220V and the status is OK. A boost AVR icon is present, and the battery level is shown as fully charged.</p>
Battery mode	When the input voltage is beyond the acceptable range or power failure and alarm is sounding every 10 seconds, UPS will backup power from battery.	 <p>The display shows two load bars (top and bottom) with 25% and 50% markers. The output voltage is 120V and the battery level is 18M. A battery icon and a low battery alarm icon are present.</p>	 <p>The display shows two load bars (top and bottom) with 25% and 50% markers. The output voltage is 220V and the battery level is 18M. A battery icon and a low battery alarm icon are present.</p>



<p>Standby mode</p>	<p>UPS is powered off without output power, but the battery is still being charged.</p>		
---------------------	---	--	---

Fault Reference Codes

Fault event	Fault code	Icon	Fault event	Fault code	Icon
Bus start failure	01	x	Inverter output short	14	SHORT
Bus over	02	x	Battery voltage too high	27	X
Bus under	03	x	Battery voltage too low	28	
Inverter soft start fail	11	x	Over temperature	41	X
Inverter voltage high	12	x	Overload	43	OVER LOAD
Inverter voltage Low	13	x	Charger failure	45	X







Warning Indicators

Warning	Icon (flashing)	Alarm
Low battery		Sounds every 2 seconds
Overload		Sounds every second
Battery not connected		Sounds every 2 seconds
Overcharge		Sounds every 2 seconds
Site wiring fault		Sounds every 2 seconds
EPO enable		Sounds every 2 seconds
Over temperature		Sounds every 2 seconds
Charger failure		Sounds every 2 seconds

Battery fault		Sounds every 2 seconds (At this time, UPS is off to remind users that something is wrong with the battery)
EEPROM error		Sounds every 2 seconds
Battery replacement		Sounds every 2 seconds

Troubleshooting

If the UPS does not operate correctly, please use the table below to troubleshoot the problems.

Symptom	Possible cause	Remedy
No indication and alarm even though the utility is normal.	The AC input power is not connected well.	Check that the input power cord is firmly connected to the utility.
	The AC input is connected to the UPS output.	Plug the AC input power cord into the AC input utility correctly.
The icon  and the warning code <i>EP</i> are flashing on LCD display and alarm is sounding every second.	EPO function is enabled.	Set the circuit to the closed position to disable EPO function.
The icon  and <i>5F</i> are flashing on LCD display and alarm is sounding every second.	Line and neutral conductors of UPS input are reversed.	Have a qualified electrician correct the input receptacle wiring.
The icon  and  are flashing on LCD display and alarm is sounding every second	The internal battery is incorrectly connected.	Check to make sure all batteries are properly connected.
Fault code is shown as 27 and the icon  is showing on LCD display and alarm is continuously sounding.	Battery voltage is too high or the charger is in fault condition.	Contact technical support.
Fault code is shown as 28 and the icon  is showing on LCD display and alarm is continuously sounding.	Battery voltage is too low or the charger is in fault condition.	Contact technical support.
Fault code is shown as 14 and alarm is sounding continuously.	The UPS shut down automatically because short circuit condition occurred on the UPS output.	Disconnect loads and check output wiring or connected devices are in short circuit status.
Fault code is shown as 01, 02, 03, 04, 11, 12, 13 and 41 on LCD display and alarm is sounding continuously.	A UPS internal fault has occurred. There are two possible results: 1. The load is still supplied, but directly by AC utility via bypass. 2. The load is no longer supplied with power.	Contact technical support.

Battery backup time is shorter than expected.	Batteries are not fully charged.	Charge the batteries for at least 5 hours and then re-check capacity. If the problem still exists, contact your dealer for support.
	Batteries are defective.	Contact technical support for battery replacement.

Storage & Maintenance

Operation

The UPS system contains no user-serviceable parts. If the battery service life (3~5 years at 25°C ambient temperature) has been exceeded, the batteries must be replaced. In this case, please contact technical support.



Be sure to deliver the spent battery to a recycling facility or ship it to your dealer in the replacement battery packing material.

Storage

Before storing, charge the UPS at least 5 hours. Store the UPS covered and upright in a cool, dry location. During storage, recharge the battery in accordance with the following table:

Storage Temperature	Recharge Frequency	Charging Duration
-25°C - 40°C	Every 3 months	1-2 hours
40°C - 45°C	Every 2 months	1-2 hours

Specifications

MODEL NUMBER		VL800A	VL1100A	VL1500A	VL2000A	VL2200A	VL3000A or VL3000A-1
CAPACITY	Power rating	800VA (720W)	1100VA (990W)	1500VA (1350W)	2000VA (1800W)	2200VA (2000W)	3000VA (2700W)
INPUT	Voltage nominal	120VAC					
	Voltage range	-32% to +27% without use of battery					
	Frequency	50/60Hz auto-sensing					
OUTPUT	Voltage	120VAC nominal (110/115/127 selectable)					
	Waveform	Pure sine wave					
	Transfer time (typical)	2–6ms					
	Efficiency	Up to 99% ECO mode, 95% buck and boost mode					
	Harmonic distortion	2% @ 100% linear load; 5% @ 100% non-linear load					
BATTERY	Battery type	Sealed, maintenance-free lead acid					
	Battery quantity/size	(2) 12V 7AH	(2) 12V 9AH	(4) 12V 7AH	(4) 12V 9AH	(6) 12V 7AH	(6) 12V 9AH
	Charging current	1.5A max					
	Typical recharge	4 hours to 90%					
PHYSICAL	Dimensions (W x D x H)	17.2 x 15.1 x 3.5 in		17.2 x 18.9 x 3.5 in		17.2 x 23.6 x 3.5 in	
	Weight	29.3 lbs	30.5 lbs	44.7 lbs	47.4 lbs	61.7 lbs	67.1 lbs
	Line cord	6 ft, 5–15P	6 ft, 5–15P	6 ft, 5–15P	6 ft, 5–20P	6 ft, 5–20P	6 ft, L5–30P
	Receptacles	(8) NEMA 5–15R			(8) NEMA 5–15/20R		(8) 5–15/20R or (6) 5–15/20R + L5-30R (V2)
OPTIONAL BATTERY PACKS	Model number	N/A		VXBP1		VXBP2	
	Dimensions (W x D x H)	N/A		17.2 x 18.9 x 3.5 in		17.2 x 23.6 x 3.5 in	
	Weight	N/A		74.6 lbs		104.4 lbs	
	Battery	N/A		(8) 12V 9AH / 48V		(12) 12V 9AH / 72V	
ENVIRONMENT	Operating temperature	32–104°F (0–40°C)					
	Audible noise	< 45dBA					
	Altitude	11,500 ft above sea level					
APPROVALS	UL, cUL, RoHS						
WARRANTY	3 years electronics, 3 years battery warranty (USA and Canada)						
COMMUNICATIONS INTERFACE	RS-232, USB, EPO, intelligent slot for optional cards (Web/SNMP)						
INCLUDED IN BOX	Software CD, horizontal brackets, tower pedestals, user manual						

Specifications

MODEL NUMBER		VL3000B	VL5000B	VL5000B-1
CAPACITY	Power rating	3000VA (2700W)	5000VA (4500W)	5000VA (4500W)
INPUT	Voltage nominal	208/220/230/240VAC		
	Voltage range	162–290VAC		
	Frequency	50/60Hz auto sensing		
OUTPUT	Voltage	208/220/230/240VAC		
	Waveform	Pure sine wave		
	Transfer time (typical)	2–6ms		
	Efficiency	Up to 99% ECO mode, 95% buck and boost mode		
	Harmonic distortion	2% @ 100% linear load; 5% @ 100% non-linear load		
BATTERY	Battery type	Sealed, maintenance-free lead acid		
	Battery quantity/size	(2) 12V 7AH	(2) 12V 9AH	(4) 12V 7AH
	Charging current	1.5A max		
	Typical recharge	4 hours to 90%		
PHYSICAL	Dimensions (W x D x H)	17.2 x 15.1 x 3.5 in		
	Weight	61.9 lbs	78.5 lbs	137 lbs
	Line cord	8 ft, detachable C19 to L6–20P	6 ft, L6–30P	6 ft, L6–30P
	Receptacles	(1) C19 + (8) C13	(1) L6–30R + (4) C19	(2) L6–30R + (2) L6–20R + (1) C19
OPTIONAL BATTERY PACKS	Model number	VXBP2	VXBP3	
	Dimensions (W x D x H)	17.2 x 23.6 x 3.5 in		
	Weight	104.4 lbs	110.4 lbs	
	Battery	(12) 12V 9AH / 72V	(12) 12V 580W at 5 min / 72V	
ENVIRONMENT	Operating temperature	32–104°F (0–40°C)		
	Audible noise	< 45dBA		
	Altitude	11,500 ft above sea level		
APPROVALS		CE, RoHS		
WARRANTY		3 years electronics, 3 years battery warranty (USA and Canada)		
COMMUNICATIONS INTERFACE		RS-232, USB, EPO, intelligent slot for optional cards (Web/SNMP)		
INCLUDED IN BOX		Software CD, horizontal brackets, tower pedestals, user manual		

OBTAINING SERVICE

If the UPS requires Service:

1. Use the TROUBLESHOOTING section in this manual to eliminate obvious causes.
2. Verify there are no circuit breakers tripped.
3. Call CPI Technical Support at 800-834-4969. Technical support inquiries can also be made at techsupport@chatsworth.com. Please have the following information available BEFORE calling the Technical Support Department:
 - Ship to address
 - The serial number of the unit.
 - Where and when the unit was purchased.
 - All of the model information about your UPS.
 - Any information on the failure, including LED's that may or may not be illuminated.
 - A description of the protected equipment, including model numbers if possible.
4. Technical Support will ask you for the above information and, if possible, help solve your problem over the phone. In the event that the unit requires factory service, the technician will issue you a Return Material Authorization number (RMA).

RETURNS AND REPAIRS

No products or part thereof shall be returned to CPI unless the customer first obtains a Return Material Authorization (RMA) Number from a CPI customer service representative. This number must appear clearly and prominently on all shipping containers. Containers without the labels will not be accepted.

If you are returning the UPS to CPI for service, please follow these procedures:

1. Pack the UPS in its original packaging. If the original packaging is no longer available, ask the Technical Support Technician about obtaining a replacement set of packaging material. It is important to pack the UPS properly in order to avoid damage in transit.
***Never use Styrofoam beads for a packing material.**
2. Mark the RMA number on the outside of all packages. CPI cannot accept any package without the RMA number noted on the outside of the boxes.
3. Return the UPS by an insured, prepaid carrier to the address provided by the Technician.
4. Refer to the Warranty statements in this manual for additional details on items covered.

RMA expires 30 Days after issuance!

Standard Limited Warranty – CPI-Branded Hardware Products

Chatsworth Products, Inc. (CPI) warrants all CPI-branded hardware products (LS-Series Uninterruptible Power Supplies) to be free from defects in material and/or workmanship (CPI's Standard Limited Warranty) for a period of three (3) years (USA & Canada) and one (1) year (outside USA & Canada) following the date of purchase (the Original Warranty Period).

The customer must contact CPI in writing or by oral communication confirmed in writing within the Original Warranty Period to report a product that the customer claims is defective. CPI reserves the sole and absolute right to determine whether or not the product or any part thereof is defective. In the event a product (or any part thereof) is determined by CPI to be defective (an Accepted Claim), CPI will provide a re-manufactured or replacement product or part (the Replacement Product) at no cost to the customer and issue a Return Material Authorization (RMA) number.

In the case of an Accepted Claim, the customer shall be responsible for shipping back the defective product to CPI under the provided RMA number within 30 days. Any exceptions to this return policy must be authorized by CPI in writing in advance. Freight charges for the return shipment of the defective product for an Accepted Claim shall be borne by the customer, unless the defect is reported by the customer to CPI in writing within the first 30 days following the customer's receipt of the original product. Any Replacement Product that has been provided under an Accepted Claim will be subject to CPI's Standard Limited Warranty for the remaining Warranty Period applicable to the original product or 90 days following the date of replacement, whichever occurs later.

CPI's Standard Limited Warranty and Extended Limited Warranty do not extend to CPI-branded hardware products that have been subjected to abuse, misuse, neglect, accident, improper use, or improper installation, operation, repair and maintenance (except to the extent provided by CPI authorized personnel), nor to products that have been altered or modified in any way by anyone other than CPI authorized personnel, in which case CPI's Standard Limited Warranty or Extended Limited Warranty shall be null and void. In no event will CPI be liable for consequential damages, for loss, damage or expense directly or indirectly arising from the use of any of its branded products, for any inability to use materials or from any other cause.

THESE LIMITED WARRANTY PROVISIONS ARE THE EXCLUSIVE WARRANTIES FOR ANY CPI-BRANDED HARDWARE PRODUCTS AND SET FORTH THE EXCLUSIVE REMEDIES AND PROCEDURES FOR CLAIMS UNDER CPI'S STANDARD LIMITED WARRANTY AND EXTENDED LIMITED WARRANTY.

CPI'S STANDARD LIMITED WARRANTY AND EXTENDED LIMITED WARRANTY APPLY TO CPI-BRANDED HARDWARE PRODUCTS ONLY.

DISCLAIMER OF WARRANTY: EXCEPT AS EXPRESSLY SET FORTH HEREIN, CPI MAKES NO OTHER WARRANTIES, EXPRESS OR IMPLIED, INCLUDING, WITHOUT LIMITATION, ANY WARRANTIES OF FITNESS FOR A PARTICULAR USE OR PURPOSE, MERCHANTABILITY, OR NON-INFRINGEMENT OF ANY INTELLECTUAL PROPERTY RIGHTS.

Appendix A: VXBP1 & VXBP2 User Guide

Important Safety Instructions

Please comply with all warnings and operating instructions in this manual strictly. Save this manual properly and read carefully the following instructions before installing the unit. Do not operate this unit before reading through all safety information and operating instructions carefully.

- Do not try to repair the unit yourself, contact your local supplier or your warranty will be void.
- To eliminate any overheating of the battery box, keep all ventilation openings free from obstruction and do not place any foreign objects on top of the battery bank. Keep the battery box 20cm away from the wall.
- Make sure the battery box is installed within the proper environment as specified. (0-40°C and 30-90% non-condensing humidity)
- Do not install the battery box under direct sunlight. Your warranty will be void if the batteries fail due to overheating.
- This battery box is not designed for use in dusty, corrosive and salty environment.
- The warranty for this battery bank will be void if water or other liquid is spilled or poured directly onto the battery box. Similarly we do not warrant any damage to the battery box if foreign objects are deliberately or accidentally inserted into the battery box enclosure.
- The battery will discharge naturally if the system is unused for a period of time.
- It should be recharged every 2-3 months if unused. If this is not done, then the warranty will be null and void. During normal operation, the batteries will automatically remain in charged condition.
- Servicing of batteries should be performed or supervised by trained personnel with knowledge of batteries and the required precautions.
- When replacing batteries, it is necessary to replace ALL batteries with the same quantity, type & capacity.
- CAUTION – Do not dispose of battery or batteries in a fire. The battery may explode.
- CAUTION – Do not open or mutilate the batteries. The electrolyte from the batteries is toxic and harmful to the skin and eyes.
- CAUTION – Risk of Electric Shock –Hazardous voltage may exist between battery terminals and ground. Test before touching with bare hands.
- CAUTION – A battery can present a risk of electrical shock and high short circuit current. The following precaution should be observed when working on batteries:
 1. Remove watches, rings, or other metal objects.
 2. Use tools with insulated handles.
 3. Wear rubber gloves and boots.
 4. Do not lay tools or metal parts on top of batteries.
 5. Disconnect charging source prior to connecting or disconnecting battery terminals.
- Do not plug or unplug the battery connector if UPS works in DC (discharging) mode.

Product Overview and Setup

NOTE: Before installation, please inspect the unit. Be sure that nothing inside the package is damaged. Please keep the original package in a safe place for future use.

Rear Panel View

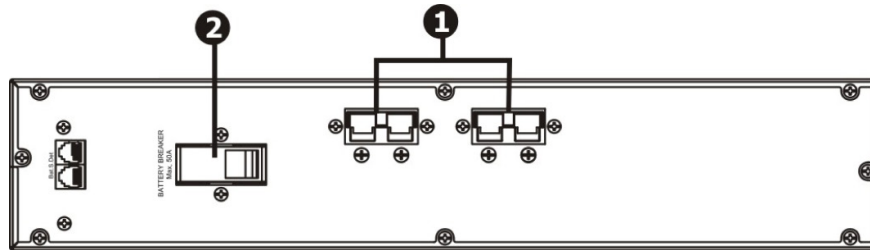

1. DC connector : connects to either UPS or 2nd battery box
2. DC breaker: Battery over-current protection breaker

Installation and Setup with UPS

Unpacking & Inspection

1. Remove the battery box from the packing.
Note: The battery box is very heavy, be cautious when unpacking and lifting the unit to avoid injury.
2. Check the inside package
 - Battery box unit
 - Manual
 - Battery connection cable x 1
 - Ear x 2 & screw x 8
 - Extended stand

Selecting Installation Position

It is necessary to select a proper environment to install the unit, in order to minimize the possibility of damage to the battery box and extend the life of the batteries. Please follow the instructions below:

1. Keep at least 20cm (8 inches) clearance from the rear panel of the unit from the wall or other obstructions.
2. Do not block the air-flow to the ventilation openings of the unit.
3. Please ensure the installation site environmental conditions are in accordance with the unit's working specifications to avoid overheat and excessive moisture.
4. Do not place the unit in a dusty or corrosive environment or near any flammable objects.
5. This unit is not designed for outdoor use.

This unit can either be rack mounted or placed vertically on the desk.

Rack Installation

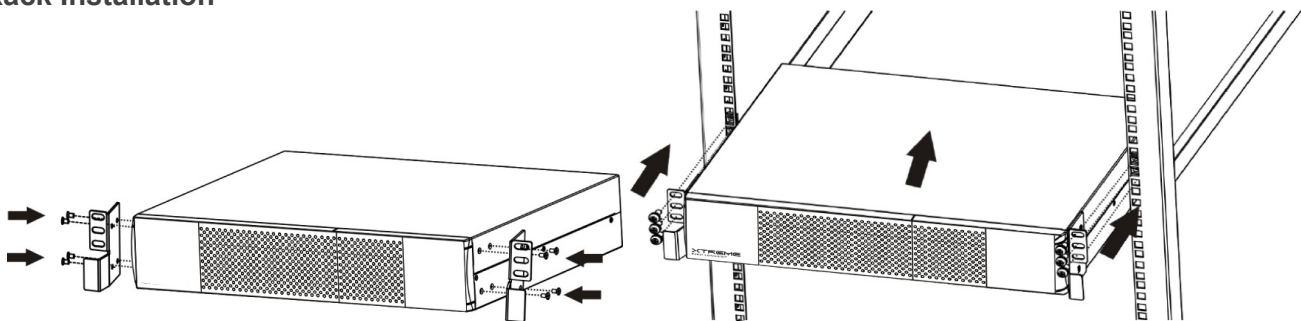

Tower Installation

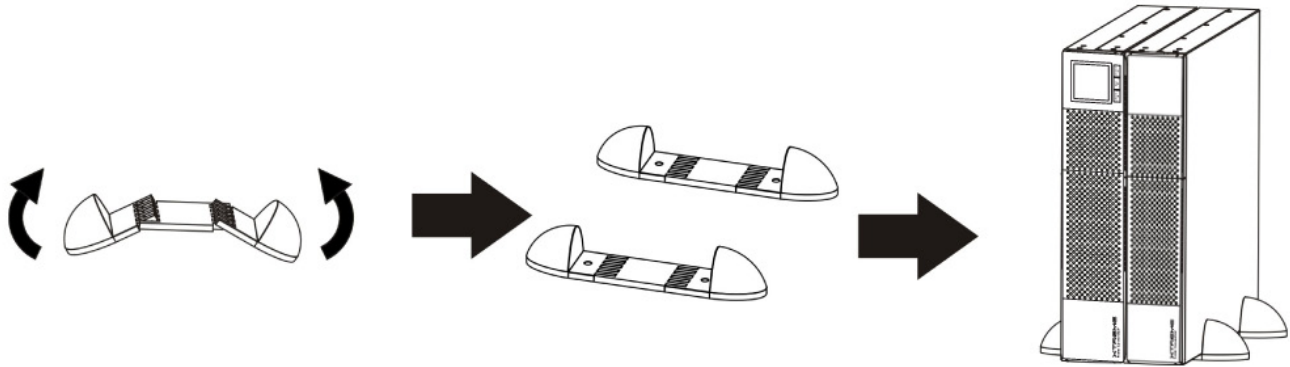

Connecting with UPS and Other Battery Box

Follow below installation chart to connect with UPS and other battery box with included cable.

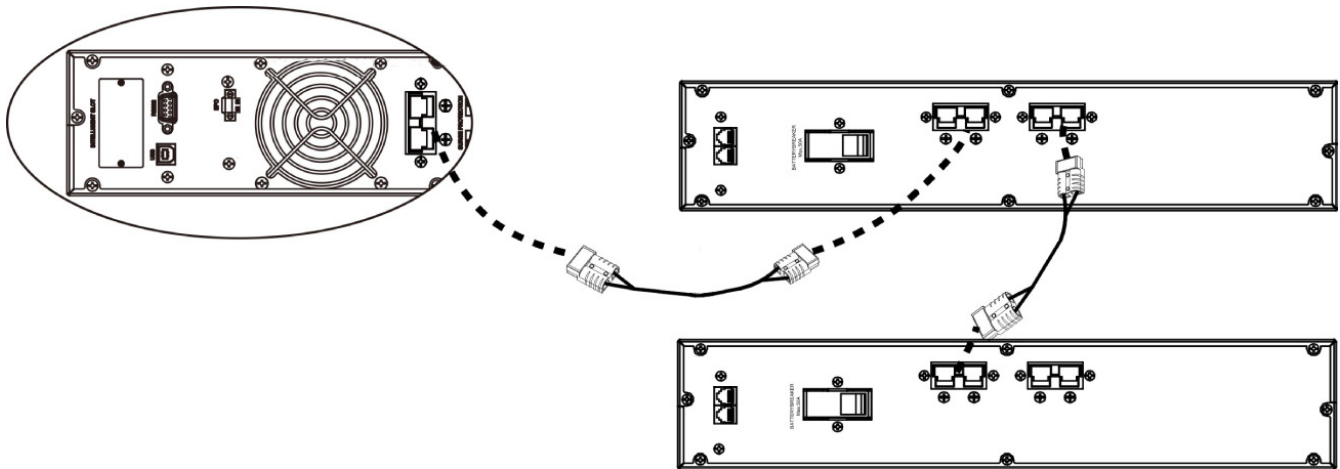

Type of Battery Required

This battery box has been designed to operate with the following types of batteries:

48V/9Ah Version: 4 pieces of 12V 9Ah batteries per string

72V/9Ah Version: 6 pieces of 12V 9Ah batteries per string

Battery Replacement

If your battery box is not installed with batteries, please follow proper procedure to put batteries inside of unit.

NOTE: MAKE SURE THAT THE BATTERY BOX IS DISCONNECTED FROM THE UPS BEFORE PERFORMING THE FOLLOWING SEQUENCE OF OPERATIONS.

VXBP1

Step 1 : Open the package and place the battery box on a horizontal plane.

Step 2: Remove the removable front panel part by pulling it from the lower extremity

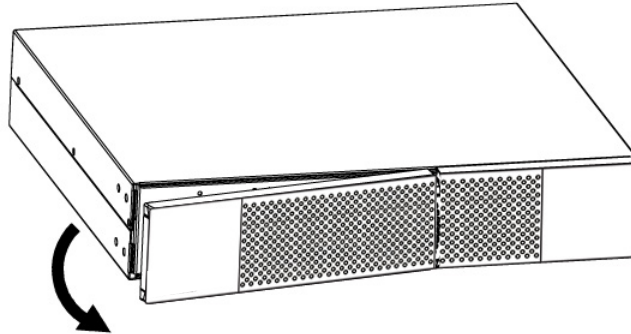

Step 3: Remove the fixed part of the front panel by removing the 2 screw present.

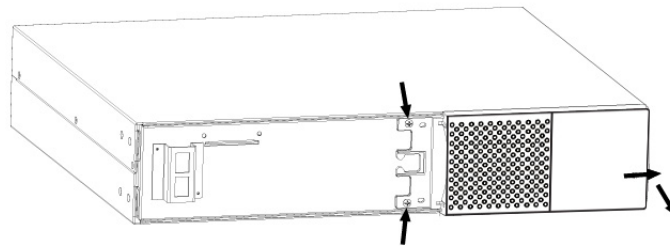

Step 4: Remove the metal top cover of the battery box by unscrewing 8 screws present on the two sides (4 on the right side and 4 on the left side), 3 screws on the top and 4 screws on the back side.

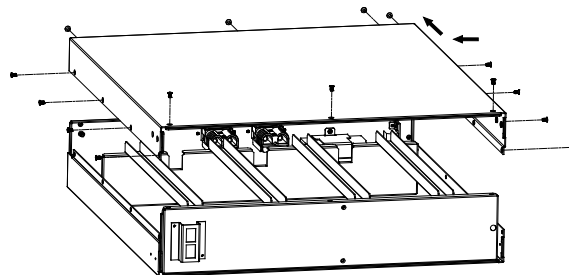

Step 5: Once the battery box is opened, remove the battery hold down brackets present on the left side of the battery box by unscrewing the 2 screws on each bracket.

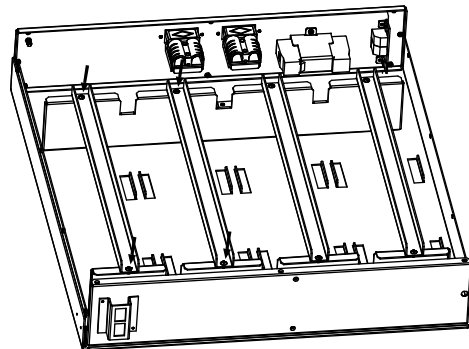

Note: To install the second string of batteries, repeat the same procedure on the battery hold down brackets on the right side of the battery box.

Step 6: Now, it is possible to put all batteries inside the unit by following the below picture (the following drawing are indicates the wire fastener positions for the correct battery placement).

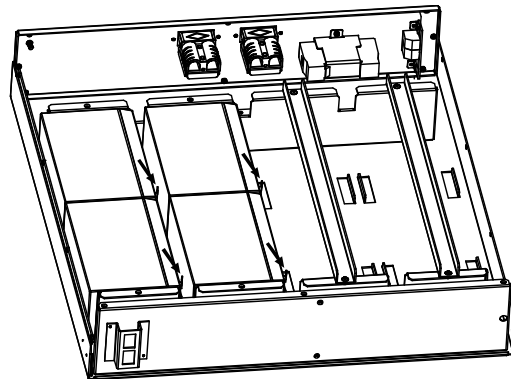

Note: To install the second string of batteries, repeat the same procedure on the right side of battery box.

Step 7: Connect all batteries following the wiring diagram shown in next chapter.

Step 8: Put all batteries inside and secure in place with hold down brackets.

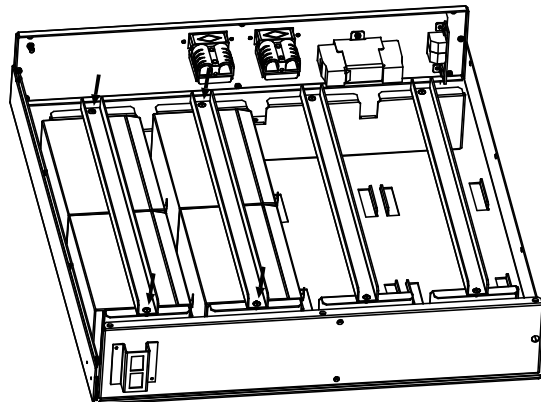

Note: To install the second string of batteries, repeat the same procedure on the right side of battery box.

Step 9: Put the metal top cover back on the unit. Close the front fixing plate and the two parts of the front panel and secure it with screws.

Step 10: Connect the battery box to the UPS.

VXBP2

Step 1 : Open the package and place the battery box on a horizontal plane.

Step 2: Remove the removable front panel part by pulling it from the lower extremity

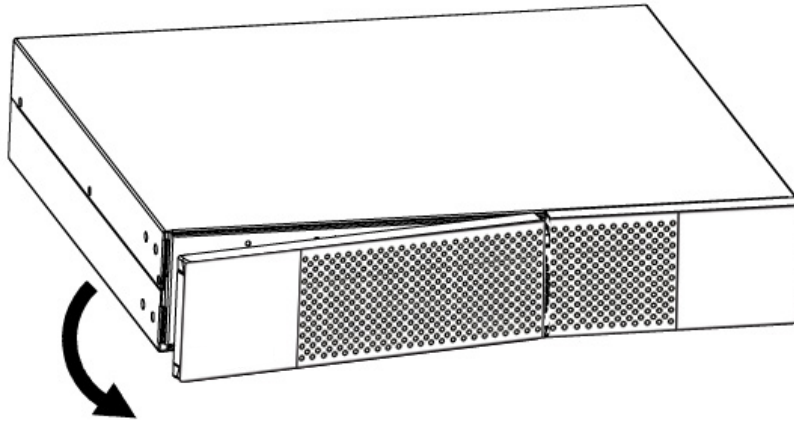

Step 3: Remove the fixed part of the front panel by removing 2 screw present.

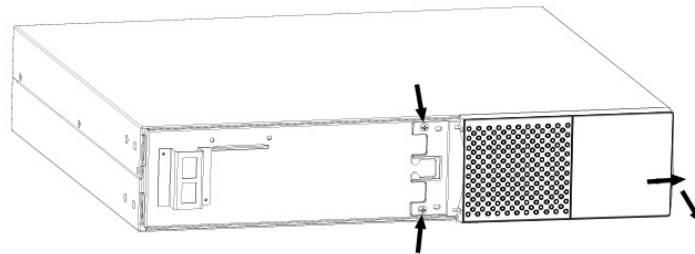

Step 4: Remove the metal top cover of the battery box by unscrewing 8 screws present on the two sides (4 on the right side and 4 on the left side), 3 screws on the top and 4 screws on the back side.

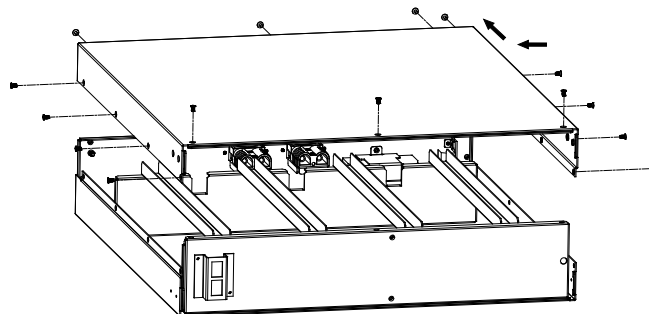

Step 5: Once battery box is opened, remove the battery hold down brackets present on the left side of the battery box by unscrewing the 2 screws on each bracket.

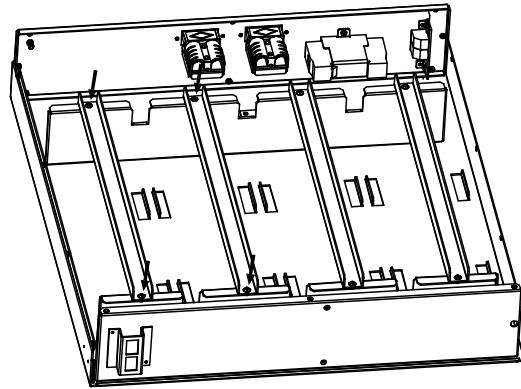

Note: To install the second branch of batteries, repeat the same procedure on the battery fixing plate on the right side of battery box.

Step 6: Now, it is possible to put the batteries inside following below picture (in the following drawing are indicated the fasten positions for the correct batteries placing).

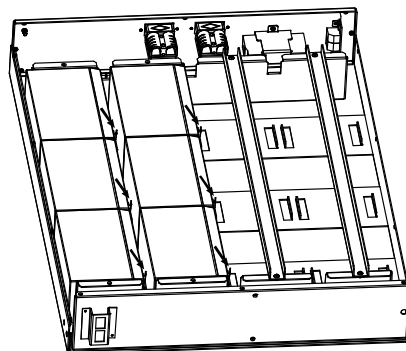

Note: To install the second string of batteries, repeat the same procedure on the right side of battery box.

Step 7: Connect all batteries following the wiring diagram shown in next chapter.

Step 8: Put all batteries inside and secure in place with the hold down brackets.

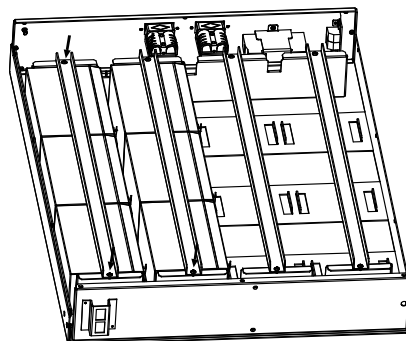

Note: To install the second string of batteries, repeat the same procedure on the right side of battery box.

Step 9: Put the metal top cover back on the unit. Close the front fixing plate and the two parts of the front panel and secure it with screws.

Step 10: Connect the battery box to the UPS.

Wiring Diagram

VXBP1

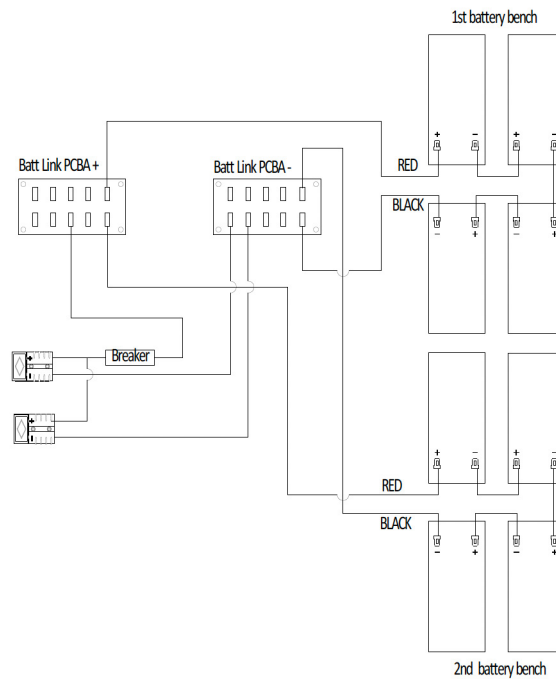

Picture example as below:

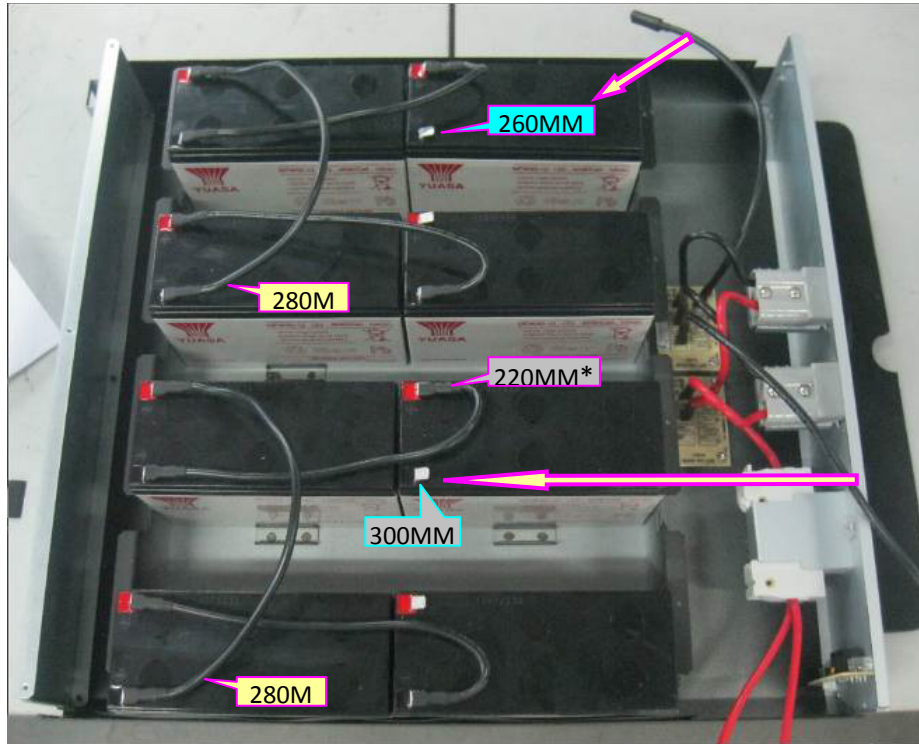

Note: The cable connection from the external battery connector to PCB is already present inside the battery box. All the other cable connections should be made in accordance with the above wiring diagram.

VXBP2

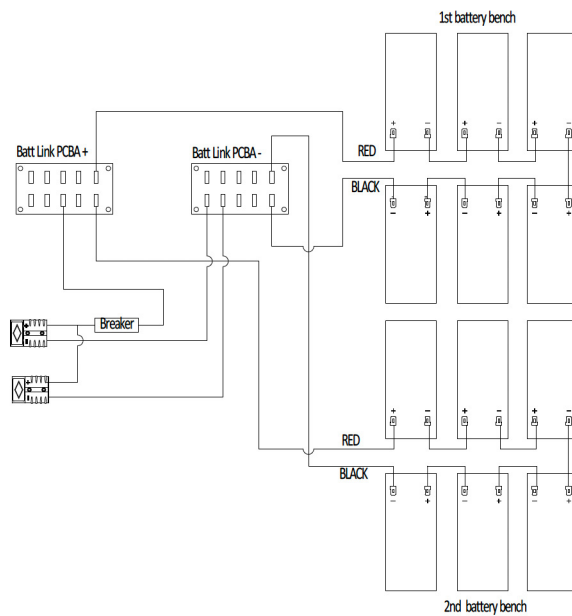

Picture example as below:

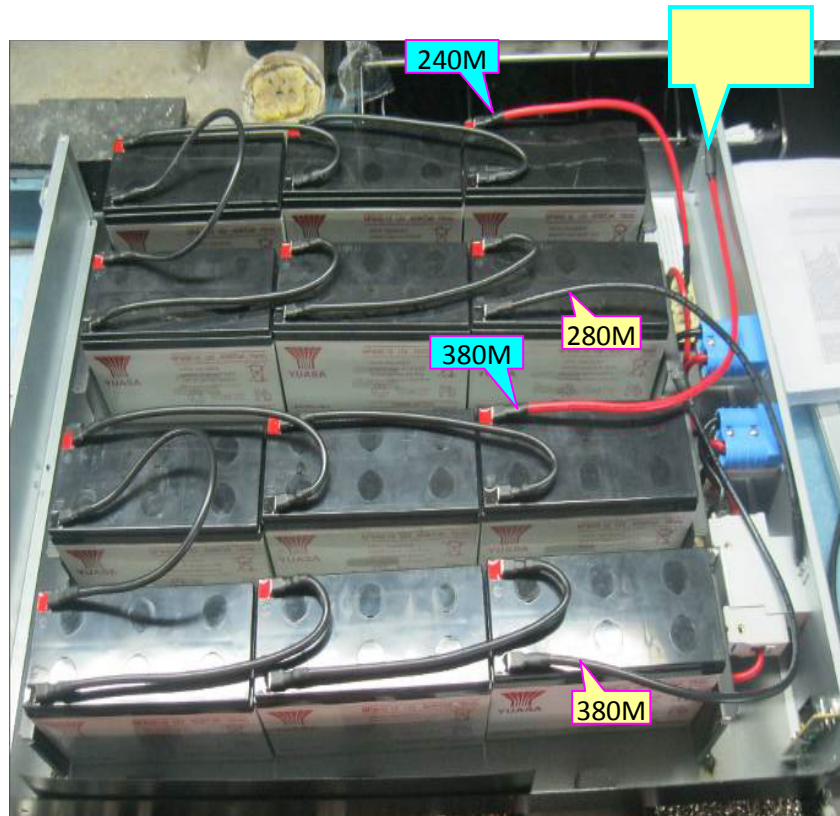

Note: The cable connection from the external battery connector to PCB is already present inside the battery box. All the other cable connections should be made in accordance with the above wiring diagram.

Storage & Maintenance

The unit contains no user-serviceable parts. If the battery service life (3~5 years at 25°C ambient temperature) has been exceeded, the batteries must be replaced. In this case, please contact technical support.

Be sure to deliver the spent battery to a recycling facility or ship it to your dealer in the replacement battery packing material.

Storage

Before storing, charge the unit 4 hours. Store the unit covered and upright in a cool, dry location. During storage, recharge the battery in accordance with the following table:

Storage Temperature	Recharge Frequency	Charging Duration
-25°C - 40°C	Every 3 months	1-2 hours
40°C - 45°C	Every 2 months	1-2 hours