



CHATSWORTH
PRODUCTS

VersaEdge™ Wall-Mount Cabinet

The VersaEdge™ Wall-Mount Cabinet delivers a scalable, modular enclosure engineered for modern edge and data center environments. With adjustable equipment rails, advanced thermal management, and quick-deployment features, it provides reliable performance, simplified serviceability, and flexible configuration options. VersaEdge combines enhanced airflow, broad accessory compatibility, and tool-less installation to optimize equipment protection and uptime in space-limited or high-performance applications.



Scalable modular design supports multiple configurations to meet diverse edge and data center requirements.

KEY FEATURES

- Adjustable equipment rails accommodate evolving configurations.
- Enhanced airflow design minimizes heat buildup and maintains temperature stability, supporting passive heat dissipation up to 10 kW.
- Optional fan kits provide additional cooling for demanding high-heat-load environments.
- Quick deployment features, including a tool-less removable cover and 180 degree swinging door, reduce installation time.
- Optional Universal Accessory Panel supports copper and fiber service loops, power supplies, and cable management systems.
- Broad accessory compatibility with UPS systems, PDUs, structured cabling, and cooling kits ensures seamless integration.
- Simplified equipment access enables fast maintenance and upgrades without disrupting network operations.
- Scalable modular design supports multiple configurations to meet diverse edge and data center requirements.
- PCI-DSS–Aligned Security for retail and payment-processing environments with lockable, tamper-resistant construction and optional electronic access control.

SPECIFICATIONS

Description	Wall-mount cabinet with metal front door and adjustable equipment rails. Provides scalable, modular design optimized for edge and data center environments.
Use	For indoor use only in environmentally controlled spaces. Not intended for outdoor installation, harsh environments, or air-handling spaces.
Available Sizes	<ul style="list-style-type: none"> • Height: 42.5" (1080 mm) • Width: 26" (660 mm); 19" EIA rack-mount rails • Depths: 12" (305 mm), 17.25" (438 mm), 22.5" (572 mm) • Rack-Mount Units (RMU): 3U, 6U, 9U
Usable Interior Space	<ul style="list-style-type: none"> • 19" EIA-310-D compliant, square-punched equipment mounting rails • Adjustable rail depth accommodates multiple configurations • Supports UPS systems, PDUs, patch panels, fan kits, and cable management accessories
Cable Access	<ul style="list-style-type: none"> • Top and bottom cable entry points for simplified routing • Optional grommet and brush kits for protected pass-throughs • Universal Accessory Panel provides center pass-through and Velcro tie-off points • Optional magnetic cable clip kit (10-piece) for flexible cable organization
Equipment Support	<ul style="list-style-type: none"> • Adjustable square-punched mounting rails, 19"W, EIA-310-D compliant • Supports both vertical and horizontal equipment orientations • Depths: Will support up to 36"D (914 mm) equipment • Multiple accessory mounting locations for fiber, copper, and power systems • UPS and cooling kit mounting compatibility
Load Capacity	625 lb (136 kg) static load rating, UL 2416 Listed

Availability: Global



United States & Canada
Simi Valley, CA
800-834-4969
Toronto, Ontario, Canada
+905-850-7770
chatsworth.com
techsupport@chatsworth.com

Latin America
Mexico City, Mexico
+52-55-5203-7525
Toll Free within Mexico
800-201-7592
chatsworth.com.co

Europe
Buckinghamshire
England, UK
+44-1628-524-834

Middle East & Africa
Dubai, UAE
+971-4-2602125

Asia Pacific
Jing'an District,
Shanghai, China
+86 21 6880-0266
chatsworth.com.cn

SPECIFICATIONS

Thermal Management	<p>Supports Passive and Active Cooling Applications</p> <ul style="list-style-type: none"> • Passive Cooling (No Fans Required): <ul style="list-style-type: none"> – Enables up to 10 kW of heat dissipation using natural airflow, with no supplemental fans required. • Active Cooling (Optional Fan Kit): <ul style="list-style-type: none"> – With the dual fan assembly accessory, supports higher heat loads. • Scalable Thermal Performance: <ul style="list-style-type: none"> – Cooling capacity scales seamlessly to support evolving edge applications.
Optional Security Features	<ul style="list-style-type: none"> • Locking front door with multiple options: <ul style="list-style-type: none"> – Swing-handle lock (keyed or swappable cores) – Combination lock (1K door code combinations) – Electronic locks (12V, 12V SSI) • Rear section secured with internal latch for controlled access
Accessory Compatibility	<ul style="list-style-type: none"> • Compatible with VersaEdge accessories including: <ul style="list-style-type: none"> – Universal Accessory Panels (Black or Glacier White) – UPS Brackets (top or bottom mounting) – Fiber Service Loop Kits – Grommet and Brush Kits • Accessories feature durable powder-coated finishes, and are UL listed
Material	<ul style="list-style-type: none"> • Heavy-duty steel cabinet body and door • Equipment mounting rails are 19" EIA, square-punched
Construction	<ul style="list-style-type: none"> • Riveted steel frame construction for strength and rigidity
Finish	<ul style="list-style-type: none"> • Durable powder coat paint; available in Black or Glacier White
Certifications	<ul style="list-style-type: none"> • UL 2416 Listed

VersaEdge™ Wall-Mount Cabinet

A modular wall-mount cabinet designed to provide flexibility for deploying switches, servers, and patch panels at the edge of the network. VersaEdge enables organizations to bring compute, storage, and connectivity closer to IoT devices and end-users through adaptable equipment configurations and scalable design. Its modular construction allows IT teams to quickly install, reconfigure, and service equipment where applications need to run closer to end devices—delivering reduced latency, improved performance, and scalability at the network edge.

VersaEdge features advanced thermal management to ensure optimal airflow and temperature control in high-density environments. Optional fan and cooling kits, magnetic blanking panel, and perforated ventilation patterns promote efficient heat dissipation. This enhanced thermal design safeguards sensitive equipment, extends service life, and delivers consistent reliability and performance for edge and distributed IT applications.

ORDERING INFORMATION:

VersaEdge™ Wall-Mount Cabinet Models			
Part Number	Cabinet Width	Cabinet Depth	Shipping Weight lb (kg)
43000-X03	26"W (660 mm)	3U, 12"D (305 mm)	68 (30.8)
43000-X06	26"W (660 mm)	6U, 17.25"D (438 mm)	83 (37.6)
43000-X09	26"W (660 mm)	9U, 22.5"D (572 mm)	98 (44.5)

Note: X=Color; 7=Black, E=Glacier White

DIMENSIONS:

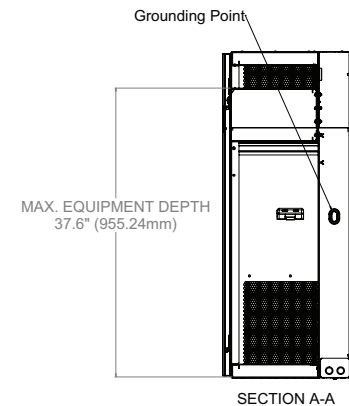
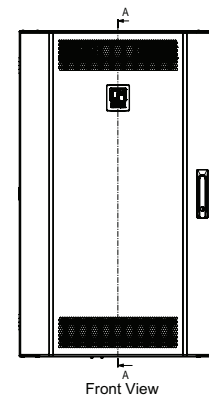
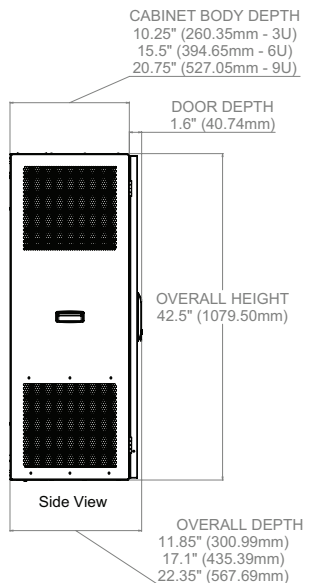
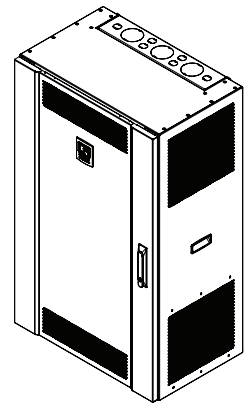
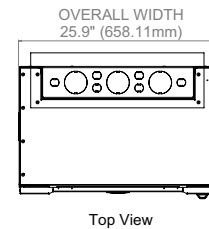
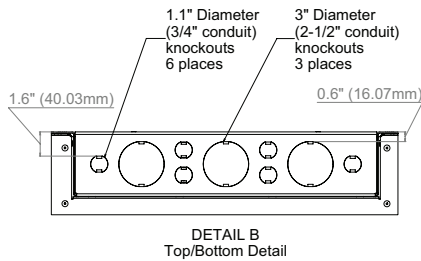

NOTE: Maximum equipment depth is obtained only when Equipment Rails are mounted at the top-most mounting location.

ORDERING INFORMATION

ACCESSORIES

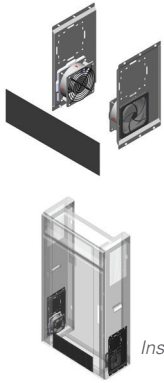
**Cooling Kits for VersaEdge™**

Provides additional airflow to support higher thermal demands and high-density edge deployments. Designed for use with VersaEdge Wall-Mount Cabinets in 3U, 6U, and 9U sizes.

- Assembly includes two panels, pair of fans, and one magnetic blanking panel
- Quiet operation with an energy-efficient fan system
- Airflow: 120 CFM (204 CMH) total (2 fans)
- Includes a 6 ft (1.8 m) NEMA 5-15P/6-15P power cord
- Available in Black and Glacier White finishes

Installed

Part Number	Description	Shipping Weight lb (kg)
43035-X03	Cooling Kit for 3U Cabinets	6 (2.7)
43035-X06	Cooling Kit for 6U Cabinets	8 (3.6)
43035-X09	Cooling Kit for 9U Cabinets	9 (4.1)

Note: X=Color; 7=Black, E=Glacier White

**Fan Kit for VersaEdge™**

Adds supplemental airflow to VersaEdge cabinets by incorporating the same fan technology used in VersaEdge Cooling Kits. Ideal for deployments requiring additional cooling capacity beyond passive airflow.

- Includes two fans per kit
- Designed for seamless integration with VersaEdge cabinets
- Compatible with all sizes of VersaEdge enclosures
- Quiet, energy-efficient fan operation
- Airflow: 120 CFM (204 CMH) each fan
- Includes a 6 ft (1.8 m) NEMA 5-15P/6-15P power cord

Installed

Part Number	Description	Shipping Weight lb (kg)
43055-001	Fan Kit, Pair of Fans	3 (1.4)

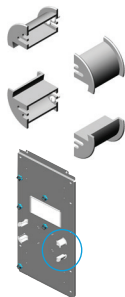
**Fiber Service Loop Kit for VersaEdge™**

Organizes fiber slack within the cabinet and prevents signal loss from over-bending.

- Includes four adjustable fiber spools
- Mounts directly to Universal Accessory Panel
- Accommodates CPI Velcro® brand cable wraps and Motive® Swivel Bundle Kit accessories
- Black finish

Part Number	Description	Shipping Weight lb (kg)
43056-001	Fiber Service Loop Kit, Four Fiber Spools, Black	2 (0.9)

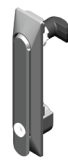

Swing-Handle Lock



Combination Lock



Electronic Lock

Locking Kits for VersaEdge™

Provides secure access and configurable protection for sensitive network equipment.

- Available in keyed, swappable-core, combination, and electronic models
- Electronic locks offered in 12V, and 12V SSI configurations (eConnect Horizontal PDU required)
- Compatible with all VersaEdge Wall-Mount Cabinet models

Part Number	Description	Shipping Weight lb (kg)
43030-710	Swing-Handle Lock, Keyed	2 (0.9)
43030-720	Swing-Handle Lock, Swappable Cores	2 (0.9)
43030-730	Combination Lock	2 (0.9)
43030-760	Electronic Lock, 12V	2 (0.9)
43030-770	Electronic Lock, 12V, SSI	2 (0.9)



Installed

Universal Accessory Panel for VersaEdge™

Provides a versatile platform for attaching cable management and power accessories within VersaEdge Wall-Mount Cabinets.

- Attaches directly to the cabinet frame
- Supports installation of UPS equipment, copper and fiber service loops, and enhanced cable management
- Recommended with:
 - Saf-T-Grip Straps, Part No. 02006-20X
 - Motive Swivel Bundle Kit, Part No. 32657-00X
- Available in Black and Glacier White finishes

Part Number	Description	Shipping Weight lb (kg)
43045-X01	Universal Accessory Panel, Black	3 (1.4)

Note: X=Color; 7=Black, E=Glacier White

**Installation Bracket for VersaEdge™**

Simplifies wall mounting and ensures precise cabinet alignment for secure installation.

- Supports quick mounting
- Designed for single-person setup using keyhole slot engagement
- Constructed from heavy-gauge steel with powder coat finish
- Compatible with all VersaEdge cabinet sizes

Part Number	Description	Shipping Weight lb (kg)
43065-701	Installation Bracket, Black	4 (1.8)

ORDERING INFORMATION

ACCESSORIES



Grommet & Brush Kit for VersaEdge™
 Provides cable ingress protection and dust management at cable entry points.

- Includes two grommets or two brush strips per kit
- Grommet kit seals openings to protect against abrasion
- Brush kit allows airflow while reducing debris infiltration
- Black finish



Magnetic Cable Manager Clip Kit for VersaEdge™
 Provides quick, tool-less cable organization using repositionable magnetic clips.

- Includes ten reusable magnetic clips per kit
- Strong magnetic base adheres to steel cabinet surfaces
- Simplifies cable routing and reconfiguration without hardware
- Ideal for temporary setups or frequent service access
- Black finish

Part Number	Description	Shipping Weight lb (kg)
43057-001	Grommet Kit, Pair, Black	1 (0.5)
43057-002	Brush Kit, Pair, Black	1 (0.5)

Part Number	Description	Shipping Weight lb (kg)
43058-001	Magnetic Cable Manager Clip Kit, 10-Piece Set, Black	2 (0.9)

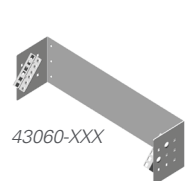

Patch Panels for VersaEdge™
 Provide mounting solutions for network connectivity at the edge.

- 2U patch panels available in multiple depths
- Optional pivoting models allow 90° access for easy serviceability
- Available in Black or Glacier White finishes

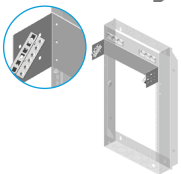

43060 Installed

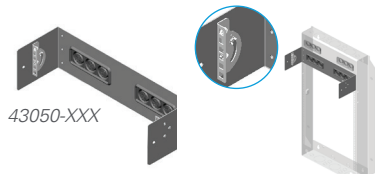

43050 Installed

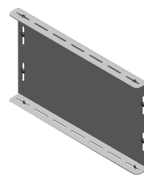

UPS Bracket for VersaEdge™
 Securely mounts compact uninterruptible power supplies within the cabinet to maintain uptime for critical network equipment.

- Installs to Universal Accessory Panel without modifying structure
- Supports UPS models: LS350A &LS600A (ordered separately, see next page)



Installed

Part Number	Description	Shipping Weight lb (kg)
43060-X02	Patch Panel, 4.5"D, 19.75" x 3.5" x 4.5" (502 x 89 x 114 mm)	4 (1.8)
43060-X03	Patch Panel, 6.25"D 19.75" x 3.5" x 6.25" (502 x 89 x 159 mm)	5 (2.3)
43060-X04	Patch Panel, 8"D, 19.75" x 3.5" x 8" (502 x 89 x 203 mm)	5 (2.3)
43050-X03	Pivoting Patch Panel, 6.25"D 19.75" x 3.5" x 6.25" (502 x 89 x 159 mm)	5 (2.3)

Note: X=Color; 7=Black, E=Glacier White

Part Number	Description	Shipping Weight lb (kg)
43048-X01	UPS Bracket, for LS350A Model	1 (0.5)
43048-X02	UPS Bracket, for LS600A Model	1 (0.5)

Note: X=Color; 7=Black, E=Glacier White



Ground Jumpers

- Provide common bonding from equipment rack or cabinet to halo conductor
- Available individually or in packages of 10
- Constructed of UL Listed components

Part Number	Description	Shipping Weight lb (kg)
40159-009	9' (2.7 m) Ground Jumper, 1 Each	2 (0.9)
40159-019	9' (2.7 m) Ground Jumper, 10 Each	20 (1.9)

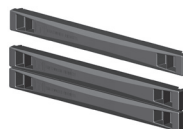

Snap-In Filler Panel
 Snap-In Filler Panel blocks airflow in between equipment by sealing unused rack-mount spaces (U) in the cabinet. Used to separate cold and hot air within the cabinet.

Part Number	Description	Shipping Weight lb (kg)
34537-X01	1U x 19"W (482.6 mm), 6 Pack	14 (6.4)
34538-X01	2U x 19"W (482.6 mm), 6 Pack	14 (6.4)

Note: X=Color; 7=Black, E=Glacier White. Also available in single and 50 packs.

ORDERING INFORMATION

ACCESSORIES

Lithium-Ion Standby UPS, 350VA–600VA

Lithium Ion Standby UPS							
Part Number	Capacity VA	Capacity W	Input Plug*	Output Receptacles	Runtime 100% load	Runtime 50% load	External Battery Option
120 Volt							
LS350A	350	200	C14 Inlet to 5-15P	(3) 5-15R	6	14	No
LS600A	600	360	C14 Inlet to 5-15P	(3) 5-15R	6	14	No
200-240 Volt							
LS350B	350	200	C14 Inlet (no cord)	(2) C13	6	14	No
LS600B	600	360	C14 Inlet (no cord)	(2) C13	6	14	No



*On 120 Volt models, included line cord is 3' (0.9 m) long. On 200-240 Volt models, order a line cord separately. C13 to required plug.

Battery Runtimes:

Estimated Runtimes On Internal Batteries (mins)										
System Load (W)	20	40	80	120	160	200	240	280	320	360
LS350x	72	35	17	11	9	7	N/A	N/A	N/A	N/A
LS600x	161	79	35	23	17	14	11	9	8	6

Note: Runtimes are shown in minutes and will vary based on battery condition, age, cycles and ambient temperature.

eConnect Horizontal PDUs (North America) for VersaEdge™ Wall-Mount Cabinet

Part Number			Input Amperage	Input Plug	Outlets	kW Capacity (UL)	Form Factor (U) Height
Black	Glacier White	Functionality					
120 Volt, Input/Output							
E0-1243-C	E0-1243-E	Basic	20A*	C20 Inlet to L5-20	(12) 5-20	1.9 kW	1U
EA-3243-C	EA-3243-E	Monitored	20A*	C20 Inlet to L5-20	(12) 5-20	1.9 kW	1U
EA-6274-C	EA-6274-E	Switched Pro	20A*	C20 Inlet to L5-20	(12) 5-20	1.9 kW	1U
100-240Volt, Input/Output							
E0-1250-C	E0-1250-E	Basic	16A	C20 Inlet to IEC 60309 16A (1P+N+E)	(12) C13	3.8 kW	1U
EA-3250-C	EA-3250-E	Monitored	16A	C20 Inlet to IEC 60309 16A (1P+N+E)	(12) C13	3.8 kW	1U
EA-6281-C	EA-6281-E	Switched Pro	16A	C20 Inlet to IEC 60309 16A (1P+N+E)	(12) C13	3.8 kW	1U



eConnect Horizontal PDU
1U, Front & Back



Field-Replaceable
Controller Module

chatsworth.com
techsupport@chatsworth.com
 800-834-4969



While every effort has been made to ensure the accuracy of all information, CPI does not accept liability for any errors or omissions and reserves the right to change information and descriptions of listed services and products.
 ©2026 Chatsworth Products, Inc. All rights reserved. Chatsworth Products, CliK-Nut, CPI, CPI Passive Cooling, CUBE-IT, Secure Array, eConnect, Evolution, GlobalFrame, MegaFrame, QuadraRack, RMR, Saf-T-Grip, SeismicFrame, SlimFrame, TeraFrame, Motive, Velocity, Oberon, Wi-Tile and ZetaFrame are federally registered trademarks of Chatsworth Products. EuroFrame, H-Plane, Hi-Bar, In-Plane, M-Frame, NetPoint, Simply Efficient, Skybar, Elevate, and VersaEdge Wall-Mount Cabinet are trademarks of Chatsworth Products and Oberon, a division of Chatsworth Products. All other trademarks belong to their respective companies. 02/2026 MKT-CPI-850