



Optima® Sensor Faucet

EBF-550-BAT-BDM-CP-2.2GPM-LAM-FCT

Product description

Battery Power Supply, Below Deck Manual Mixing Valve, Polished Chrome Finish, 2.2 gpm, Laminar Spray, Infrared Sensor, Optima® Battery or Turbine-Powered Wall-Mounted Gooseneck Body Faucet.

Compliances & Certifications



(ADA Compliant, ASME A112.18.1 Compliant, EPD, HPD, IAPMO, NSF-61/CAN-61, Proposition 65, TAS, UPC Low Lead Certified, WELL Building Standard)

Code 3315162BT







Finish

 Polished Chrome (CP)

Connectivity

 Bluetooth with Sloan Connect App

Downloads

-  [Optima Smart Faucet Below Deck Installation Instructions.pdf](#)
-  [Faucet Spray Heads Maintenance Guide.pdf](#)
-  [EBF-550-EBF-550-S-ETF-500-ETF-500-S-BT.pdf](#)
-  [Faucet and Soap Dispenser Brochure.pdf](#)
-  [Optima Faucets Brochure.pdf](#)
-  [Optima Faucets Brochure.pdf](#)
-  [Additional Downloads](#)

Videos

 [Sloan Connect App®](#)

Details

- Flow Rate: 2.2 gpm (8.3 Lpm) (2.2GPM)
- Spray Type: Laminar (LAM)
- Sensor Type: Infrared
- Mounting Type: Single Hole
- Mounting Size: Single Hole 1"
- Power Supply: Battery (BAT)
- Temperature Mixer: Below Deck Manual Mixing Valve (BDM)
- Finish: Polished Chrome (CP)
- Factory Default Timeout: 30s
- Factory Default GPC: 1.1 gpc

Features

Commercial Grade, ADA Compliant, Electronic, Sensor-Activated, Hand Washing Faucet with the following features:

- Commercial Grade Faucet
- ADA Compliant
- Cast Brass Spout
- Quick Connect Fittings
- Integrated Water Shut-off
- Wireless Settings Adjustment
- On-demand or Metered activation
- Hygienic Line Flush
- Water Usage and Battery Strength Reporting
- Self-adapting Sensor
- Chrome plated finish

Recommended specifications

Faucet shall include cast brass body, quick-connect fittings, twist-off/shut-off solenoid assembly, removable battery cartridge, flexible power supply and allow adjustment of settings wirelessly via Apple or Android smartphones.

Electrical specifications

- Battery Life: 3 years 8,000 cycles/month
- Optional power harvesting significantly extends service life
- Sensor Range: 8" -10" (152-254 mm)
- Timeout Adjustment Setting: 30 Seconds

Power Supply Options

- 6VDC Plug Adapter (sold separately)/0362006
- 6VDC Ganged Adapter Kit (up to 6 units)(sold separately)/0362035
- 24VAC Box Transformer (up to 3 units)(sold separately)/0345370PK
- Optional Turbine Energy Harvesting

Warranty

[View Warranty Information](#)

Notes

All information contained within this document subject to change without notice.

Looking for other variations of the EBF-550 product? [View the general spec sheet with all options.](#)

[Find a matching soap dispenser](#) for this faucet.

[Find a compatible sink](#) for this faucet

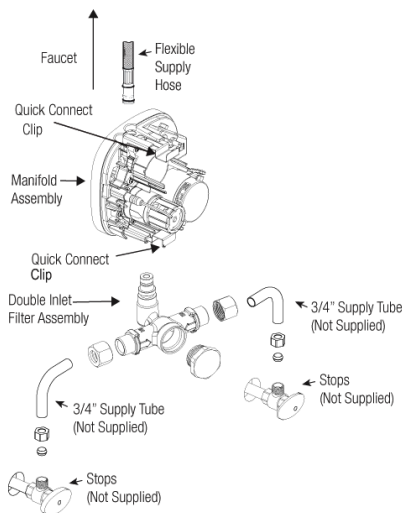

Double Inlet Filter Fitting

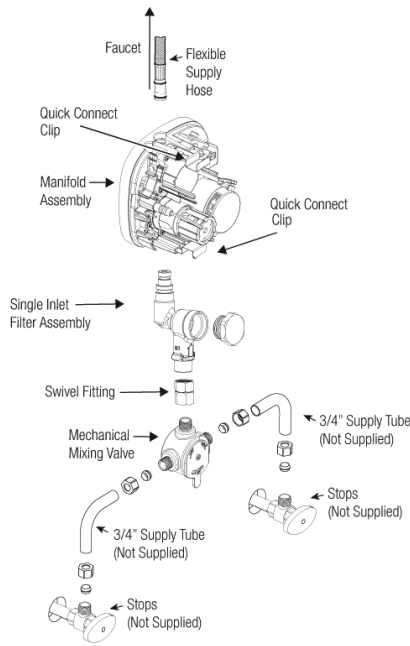

Single Inlet Filter Fitting Kit with Below Deck Manual Mixing Valve (BDM)

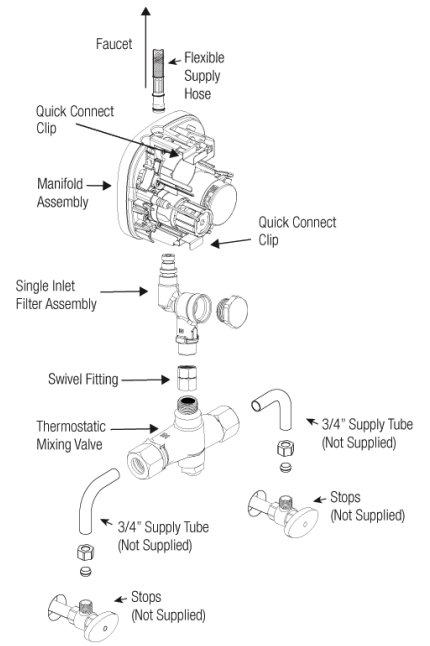

Single Inlet Filter Fitting Kit with Below Deck Thermostatic Mixing Valve (BDT)

