



Variation not shown: 8" Trim Plate

BASYS[®] Sensor Faucet

EFX-275-8-SOL-ISM-CP-1.5GPM-FCT

Product description

8" Trim Plate, Solar Power Supply, Integrated Side Mixer, Polished Chrome Finish, 1.5 gpm, Aerated (installed) or Laminar (in box) Spray, Infrared Sensor, BASYS[®] Solar-Powered Deck-Mounted Mid Body Faucet.

Compliances & Certifications



(ADA Compliant, ASME A112.18.1 Compliant, CEC Compliant, EPD, HPD, IAPMO, Proposition 65, TAS, UPC Low Lead Certified, WELL Building Standard)







Code 3324078

Finish

-  Polished Chrome (CP)

Connectivity

Downloads

-  [EFX 1Xx_2Xx Installation Instructions.pdf](#)
-  [EFX 1Xx_2Xx \(SP\) Installation Instructions.pdf](#)
-  [Trim Plate Guide.pdf](#)
-  [IR FAQs Repair and Maintenance Guide.pdf](#)
-  [Faucet and Soap Dispenser Brochure.pdf](#)
-  [Additional Downloads](#)

Videos

-  [Sloan Connect App[®]](#)
-  [BASYS[®] Faucet Installation and Features](#)
-  [BASYS[®] Faucet Installation Mid Height Model](#)

Product Information

Details

- Flow Rate: 1.5 gpm (5.7 Lpm) (1.5GPM)
- Spray Type: Aerated (installed) or Laminar (in box)
- Sensor Type: Infrared
- Mounting Type: Single Hole
- Trim Plate: 8" (203 mm) (8)
- Power Supply: Solar (SOL)
- Temperature Mixer: Integrated Side Mixer (ISM)
- Finish: Polished Chrome (CP)
- Factory Default Timeout: 10s
- Factory Default GPC: 0.75 gpc

Features

Commercial Grade, ADA Compliant, Electronic, Sensor-Activated, Die-Cast Metal Hand Washing Faucet with the following features:

- One tool service
- All wetted components to be stainless steel, engineered thermoplastic, EPDM, and copper or copper alloy
- Solenoid housed in removable carrier that includes supply strainer
- Integral water supply shut off
- Supply strainer serviceable from above deck
- Vandal resistant spray insert, key housed inside faucet body
- All electronics sealed to IP-67
- Gold plated electrical contacts
- Above deck individual diagnostic indicators for battery life, solenoid condition, and power-up mode
- Flexible, high pressure supply hoses, 3/8" compression connections
- Bi-stable magnetic solenoid
- Four (4) "AA" alkaline batteries
- Double infrared sensors with automatic setting feature
- Single hole installation
- Includes all mounting hardware
- Line purge mode, eliminates stagnant water
- Adjustable time-outs
- 3 year limited warranty
- Chrome plated finish

EFX-275-8-SOL-ISM-CP-1.5GPM-FCT

Recommended specifications

Sloan BASYS Model No. EFX-275-8-SOL-ISM-CP-1.5GPM-AER-IR-FCT Infrared Sensor Activated Electronic Handwashing Faucet for pretempered or hot/cold water supplies. Product to have double infrared sensors with automatic setting feature. Solenoid valve housed in removable carrier that closes water supply upon removal eliminating, need to access control stops. Solenoid carrier includes strainer for easy above deck service. Thermostatic mixer ordered separately to comply with ASSE 1070 requirements. The product shall be tested and certified to industry standards: ASME A112.18.1M, CSA B125.1, California Health and Safety Code 116875

Electrical specifications

- Battery Life: 3 years 8,000 cycles/month
- Optional power harvesting significantly extends service life
- Sensor Range: 4" -5" (102-127 mm)

Warranty

[View Warranty Information](#)

Notes

All information contained within this document subject to change without notice.

Looking for other variations of the EFX-275 product? [View the general spec sheet with all options.](#)

[Find a matching soap dispenser](#) for this faucet.

[Find a compatible sink](#) for this faucet

EFX-275.00X.0X0X Faucet
with Single Line Water Supply

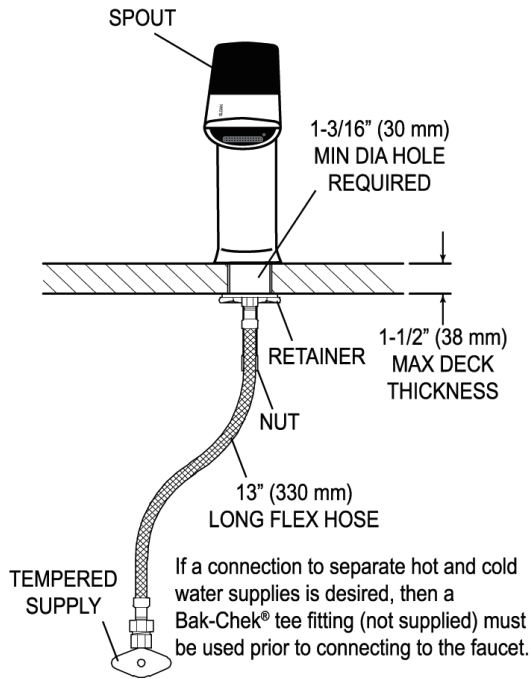

EFX-275.50X.0X0X Faucet
with Hot & Cold Water Supply

