



## Optima® Sensor Faucet

EBF-550-BAT-BDT-CP-2.2GPM-LAM-FCT

### Product description

Battery Power Supply, Below Deck Thermostatic Mixing Valve, Polished Chrome Finish, 2.2 gpm, Laminar Spray, Infrared Sensor, Optima® Battery or Turbine-Powered Wall-Mounted Gooseneck Body Faucet.

### Compliances & Certifications



(ADA Compliant, ASME A112.18.1 Compliant, ASSE 1070, EPD, HPD, IAPMO, NSF-61/CAN-61, Proposition 65, TAS, UPC Low Lead Certified, WELL Building Standard)

Code 3315098BT







### Finish

 Polished Chrome (CP)

### Connectivity

 Bluetooth with Sloan Connect App

### Downloads

-  [Optima Smart Faucet Below Deck Installation Instructions.pdf](#)
-  [Faucet Spray Heads Maintenance Guide.pdf](#)
-  [EBF-550-EBF-550-S-ETF-500 ETF-500-S-BT.pdf](#)
-  [Faucet and Soap Dispenser Brochure.pdf](#)
-  [Optima Faucets Brochure.pdf](#)
-  [Optima Faucets Brochure.pdf](#)
-  [Additional Downloads](#)

### Videos

 [Sloan Connect App®](#)

## Details

- Flow Rate: 2.2 gpm (8.3 Lpm) (2.2GPM)
- Spray Type: Laminar (LAM)
- Sensor Type: Infrared
- Mounting Type: Single Hole
- Mounting Size: Single Hole 1"
- Power Supply: Battery (BAT)
- Temperature Mixer: Below Deck Thermostatic Mixing Valve (BDT)
- Finish: Polished Chrome (CP)
- Factory Default Timeout: 30s
- Factory Default GPC: 1.1 gpc

## Features

Commercial Grade, ADA Compliant, Electronic, Sensor-Activated, Hand Washing Faucet with the following features:

- Commercial Grade Faucet
- ADA Compliant
- Cast Brass Spout
- Quick Connect Fittings
- Integrated Water Shut-off
- Wireless Settings Adjustment
- On-demand or Metered activation
- Hygienic Line Flush
- Water Usage and Battery Strength Reporting
- Self-adapting Sensor
- Chrome plated finish

## Recommended specifications

Faucet shall include cast brass body, quick-connect fittings, twist-off/shut-off solenoid assembly, removable battery cartridge, flexible power supply and allow adjustment of settings wirelessly via Apple or Android smartphones.

## Electrical specifications

- Battery Life: 3 years 8,000 cycles/month
- Optional power harvesting significantly extends service life
- Sensor Range: 8" -10" (152-254 mm)
- Timeout Adjustment Setting: 30 Seconds

## Power Supply Options

- 6VDC Plug Adapter (sold separately)/0362006
- 6VDC Ganged Adapter Kit (up to 6 units)(sold separately)/0362035
- 24VAC Box Transformer (up to 3 units)(sold separately)/0345370PK
- Optional Turbine Energy Harvesting

## Warranty

[View Warranty Information](#)

## Notes

All information contained within this document subject to change without notice.

Looking for other variations of the EBF-550 product? [View the general spec sheet with all options.](#)

[Find a matching soap dispenser](#) for this faucet.

[Find a compatible sink](#) for this faucet

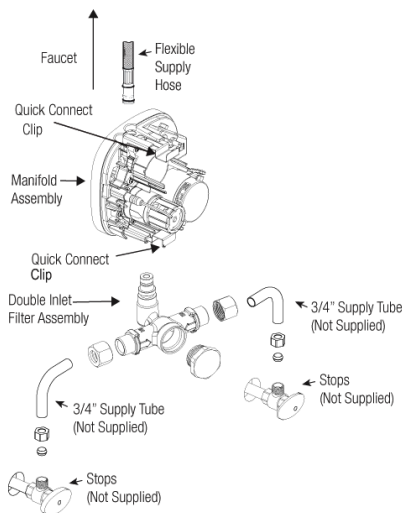

**Double Inlet Filter Fitting**

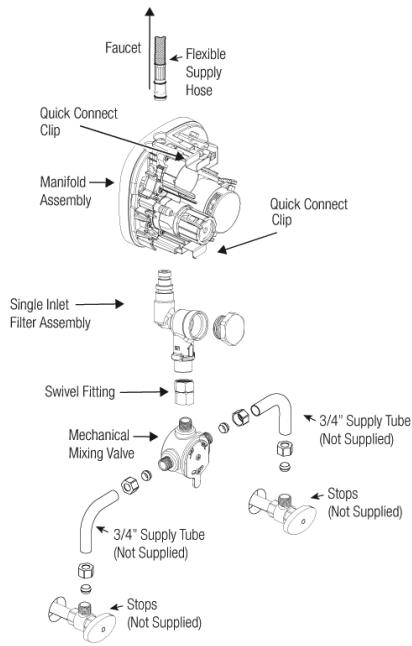

**Single Inlet Filter Fitting Kit with Below Deck Manual Mixing Valve (BDM)**

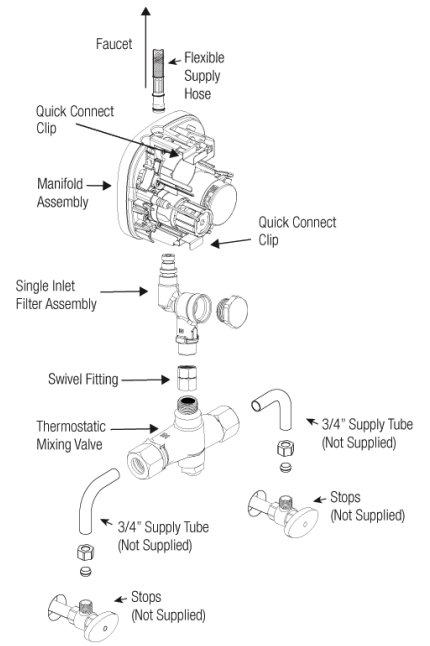

**Single Inlet Filter Fitting Kit with Below Deck Thermostatic Mixing Valve (BDT)**

