

# ROYAL ESS WATER CLOSET SENSOR AND WALL PLATE INSTALLATION INSTRUCTIONS

## ESS SENSOR WALL PLATE WITH OVERRIDE KIT

For ESS TMO instructions, see next page.

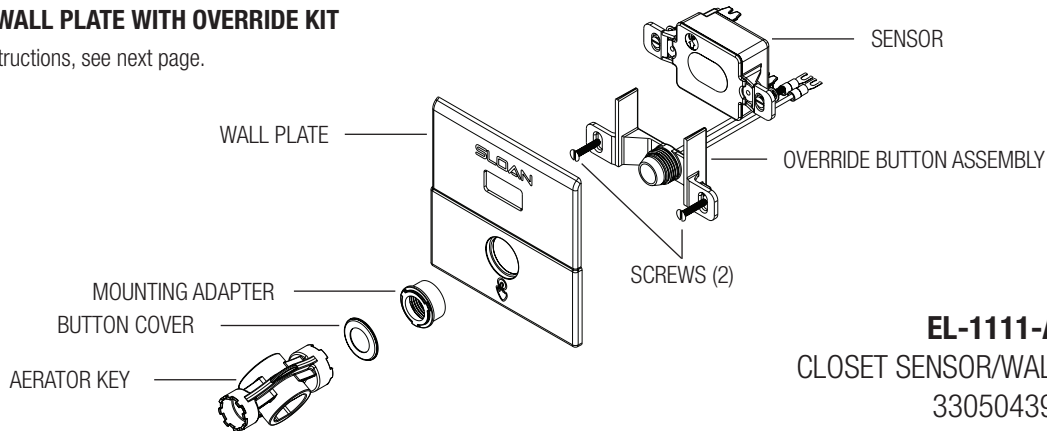

**EL-1111-A**  
CLOSET SENSOR/WALL PLATE KIT  
33050439

### SLOAN® LIMITED WARRANTY SUMMARY

Sloan Valve Company ("Sloan"), warrants its products against defects in materials and workmanship, excluding damage caused by matters beyond Sloan's reasonable control. Instructions for filing claims can be found in the Limited Warranty which can be obtained at [www.sloan.com](http://www.sloan.com) or by requesting a free copy by telephone at 888.756.2614. Sloan will repair or replace your defective product, or provide a refund, as your exclusive remedy. This is only a general summary of Sloan's Limited Warranty so it is important to note that the specific terms, conditions, limitations and exclusions, including the duration of warranty coverage for your particular Sloan product, are contained in the actual Sloan Limited Warranty. The Limited Warranty is subject to applicable laws in your country, state, province or other jurisdiction—and disputes arising under the Limited Warranty are to be resolved by binding arbitration unless you provide Sloan with an opt-out notice no later than 30 days after your purchase date. In case of a conflict with this summary, the terms and conditions set forth in the complete Limited Warranty will prevail.

- 1 Mount mud ring or electrical box (provided by others) with tab screws on the left and right sides.

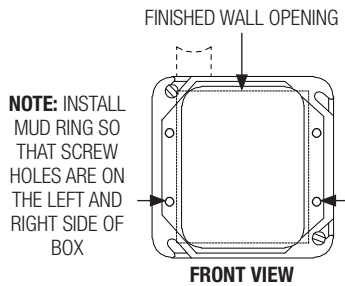

- 2 Connect (1) 24-VAC power wire to "24-VAC IN" sensor terminal screw and (1) solenoid wiring to "TO VALVE" sensor terminal screw, also connect override button wires to each sensor terminal screw.

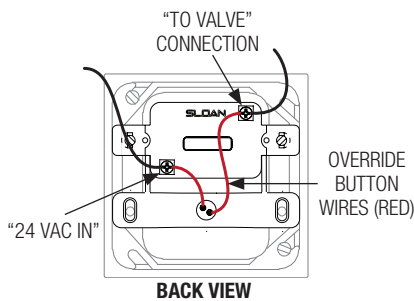

- 3 Mount the sensor to the mud ring. Ensure the sensor lens faces outward and horizontally from finished wall. Mount button retaining bracket to mud ring below sensor using screws provided.

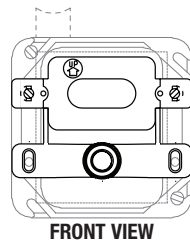

- 4 Align wall plate over button.



- 5 Thread mounting adapter onto button retaining bracket.

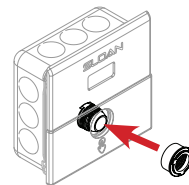

- 6 Tighten mounting adapter with supplied aerator tool by rotating clockwise. **Do not overtighten.**

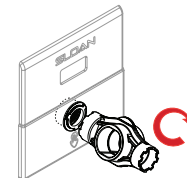

- 7 Assemble button cover onto mounting adapter with indent facing down.

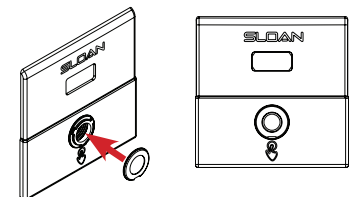

If assistance is required, please contact Sloan Technical Support at +1 888.SLOAN.14 or +1 888.756.2614

# ROYAL ESS TMO WATER CLOSET SENSOR AND WALL PLATE INSTALLATION INSTRUCTIONS

## ESS TMO SENSOR WALL PLATE LESS OVERRIDE

For ESS instructions, see previous page.

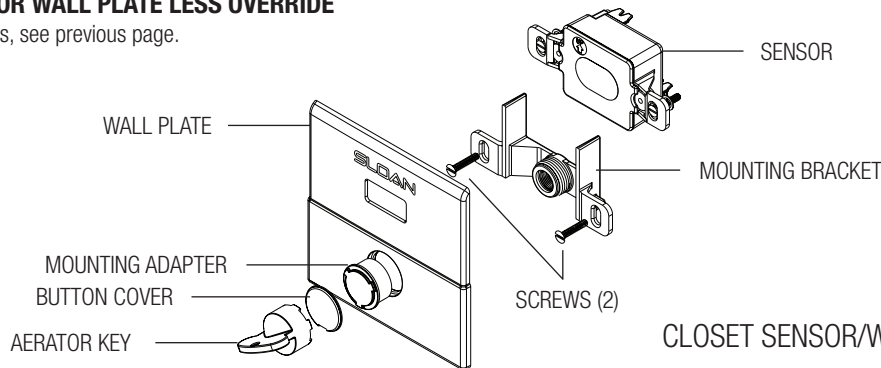

**EL-1112-A**  
CLOSET SENSOR/WALL PLATE KIT LESS OVERRIDE  
33050446

### SLOAN® LIMITED WARRANTY SUMMARY

Sloan Valve Company ("Sloan"), warrants its products against defects in materials and workmanship, excluding damage caused by matters beyond Sloan's reasonable control. Instructions for filing claims can be found in the Limited Warranty which can be obtained at [www.sloan.com](http://www.sloan.com) or by requesting a free copy by telephone at 888.756.2614. Sloan will repair or replace your defective product, or provide a refund, as your exclusive remedy. This is only a general summary of Sloan's Limited Warranty so it is important to note that the specific terms, conditions, limitations and exclusions, including the duration of warranty coverage for your particular Sloan product, are contained in the actual Sloan Limited Warranty. The Limited Warranty is subject to applicable laws in your country, state, province or other jurisdiction—and disputes arising under the Limited Warranty are to be resolved by binding arbitration unless you provide Sloan with an opt-out notice no later than 30 days after your purchase date. In case of a conflict with this summary, the terms and conditions set forth in the complete Limited Warranty will prevail.

- 1 Mount mud ring or electrical box (provided by others) with tab screws on the left and right sides.

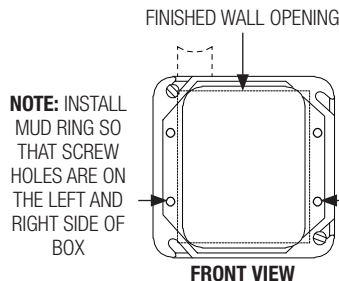

- 2 Connect (1) 24-VAC power wire to "24-VAC IN" sensor terminal screw and (1) solenoid wiring to "TO VALVE" sensor terminal screw.

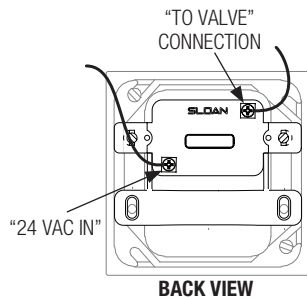

- 3 Mount the sensor to the mud ring. Ensure the sensor lens faces outward and horizontally from finished wall. Mount retaining bracket to mud ring below sensor using screws provided.

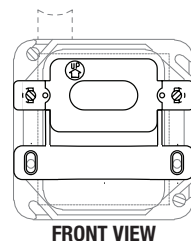

- 4 Align wall plate over mounting bracket.



- 5 Thread mounting adapter onto mounting bracket.

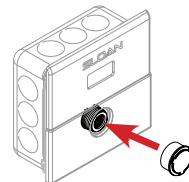

- 6 Tighten mounting adapter with supplied aerator tool by rotating clockwise. **Do not overtighten.**

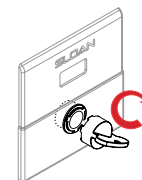

- 7 Assemble button cover onto mounting adapter with indent facing down.

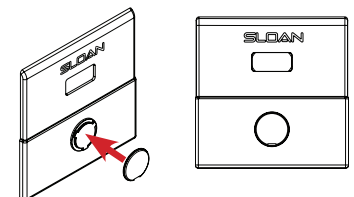

If assistance is required, please contact Sloan Technical Support at +1 888.SLOAN.14 or +1 888.756.2614

**SLOAN • 10500 SEYMOUR AVENUE • FRANKLIN PARK, IL 60131**  
Phone: 1-800-982-5839 or 1-847-671-4300 • Fax: 1-800-447-8329 or 1-847-671-4380 • [sloan.com](http://sloan.com)